

**NARVA**  
DAS LICHT



**ILUMINACIÓN  
PARA EL AUTOMÓVIL**

---

Catálogo 2022

# CONTENIDO

## LED

### 12/24V COCHE & CAMIÓN



<b>¿QUÉ TIPO DE LÁMPARA NECESITA?</b> 10	<b>SEÑALIZACIÓN E ILUMINACIÓN DE INTERIOR</b>	
<b>LÁMPARAS DELANTERAS</b>	Range Performance LED	13
Range Performance LED		12

## HALÓGENAS

### 12V COCHE



<b>¿QUÉ TIPO DE LÁMPARA NECESITA?</b> 18	<b>SEÑALIZACIÓN E ILUMINACIÓN DE INTERIOR</b>	
<b>LÁMPARAS DELANTERAS</b>	Standard	30
Standard	Lámparas halógenas en miniatura	32
Long Life	Lámparas indicadoras de base en cuña	32
Range Power 50+	Lámparas Festoon	33
Range Power 150	Lámparas con base plástica (Bax)	34
Range Power Blue+	Range Power Blue+	36
Range Power White		
Rallye	<b>KITS DE REPUESTOS</b>	38
Tipos americanos	<b>HERRAMIENTAS DE VENTAS</b>	39
		28

### 24V CAMIÓN



<b>¿QUÉ TIPO DE LÁMPARA NECESITA?</b> 41	Lámparas halógenas en miniatura	45
<b>LÁMPARAS DELANTERAS</b>	Lámparas indicadoras de base en cuña	46
Standard	Lámparas Festoon	46
Heavy Duty	Lámparas con base plástica (Bax)	47
Rallye	Heavy Duty	48
	<b>KITS DE REPUESTOS</b>	49
<b>SEÑALIZACIÓN E ILUMINACIÓN DE INTERIOR</b>	<b>HERRAMIENTAS DE VENTAS</b>	49
Standard		44

### 12V DOS RUEDAS



<b>¿QUÉ TIPO DE LÁMPARA NECESITA?</b> 51	<b>LÁMPARAS DELANTERAS</b>	
	Standard	52

## XENON

### COCHE & CAMIÓN



<b>¿QUÉ TIPO DE LÁMPARA NECESITA?</b> 57	<b>LÁMPARAS DELANTERAS</b>	
	Standard	59

<b>ILUSTRACIONES TÉCNICAS</b>	60
<b>CASQUILLOS (IEC 60061-1)</b>	62
<b>EMBALAJE</b>	64

# LOS EXPERTOS EN ILUMINACIÓN DEL AUTOMÓVIL



Si desea más información sobre NARVA, visite nuestra página web en  
[WWW.NARVA-LIGHT.COM](http://WWW.NARVA-LIGHT.COM)

## NUESTROS CLIENTES SON LO PRIMERO

**En NARVA, la satisfacción de los clientes es nuestra principal prioridad.**

En NARVA, la satisfacción de los clientes es nuestra principal prioridad. NARVA suministra productos de iluminación para automoción de alta calidad para que los profesionales puedan satisfacer plenamente las necesidades de sus clientes.

Con NARVA, los talleres y las tiendas pueden prestar un servicio y entregar productos de calidad a un precio asequible. NARVA ha desarrollado una completa cartera de productos para atender las necesidades de profesionales de todo el mundo. Los equipos y distribuidores especiales de NARVA están dedicados a la tarea de atender e informar a nuestros clientes internacionales. Trabajamos para atender con eficiencia y eficacia las exigencias de todos los clientes y mercados, en todas las áreas de nuestro negocio. Nuestras oficinas de ventas en colaboración con un almacén central,

ofrecen un cordial servicio de atención al cliente y un servicio de entregas muy eficiente.

Los equipos y distribuidores especiales de NARVA están dedicados a la tarea de proporcionar un servicio extraordinario a los clientes en todas las áreas de nuestro negocio. Mostramos nuestra preocupación por nuestros clientes ofreciéndoles un producto de calidad a un precio asequible.

A medida que las carreteras actuales están cada vez más congestionadas, creemos que es necesario que todos los conductores puedan permitirse una solución de iluminación fiable y de alta calidad para una mayor seguridad y visibilidad.

**ILUMINACIÓN DE CALIDAD A UN PRECIO ASEQUIBLE, AHORA AL ALCANCE DE TODOS.**

## NUESTRA CALIDAD ASEQUIBLE

- / NARVA, más de 70 años de experiencia en iluminación del automóvil
- / Pruebas exhaustivas durante todo el proceso de producción
- / Control de calidad constante de todas y cada una de las lámparas
- / Cumplimiento de pruebas y procesos de certificación internacional, como IATF 16949, DIN EN ISO 14001, ECE R37, ECE R99
- / Inversión permanente en innovación de productos y procesos nuevos

Nuestros productos cumplen las normas ECE\* y otros requisitos legales. (Consulte ¿Qué solución de iluminación necesita? en la página 2 para descubrir todos los productos de iluminación certificados ECE). La producción de NARVA, así como los procesos de marketing y logística, se someten a controles periódicos con ayuda de las normas internacionales IATF más actuales. ECE creó unas directrices internacionales para el sector de automoción y sus proveedores, con el objetivo de reducir las barreras comerciales y aumentar la seguridad

del tráfico. En Europa se prohíbe la venta de productos no conformes con las normas ECE.

Los productos de NARVA se adhieren a ECE Reglamento 37 para lámparas de incandescencia y 99 para lámparas de descarga de gas que proporcionan pautas que incluyen mediciones, flujo luminoso y poder.

La ISO/TS 16949 es la prueba de nuestra sólida integración de la seguridad y la estabilidad en los procesos de producción, marketing y logística.

Los más de 70 años de experiencia y especialización definen a todas las soluciones de iluminación de NARVA. NARVA siempre está sometiendo sus productos de iluminación para la automoción a pruebas, a fin de mejorar y asegurar la calidad constante de los mismos. El cumplimiento de todas las pruebas de calidad garantiza la fiabilidad de todos los productos NARVA.

\*ECE = Economic Commission for Europe (comisión económica para Europa)

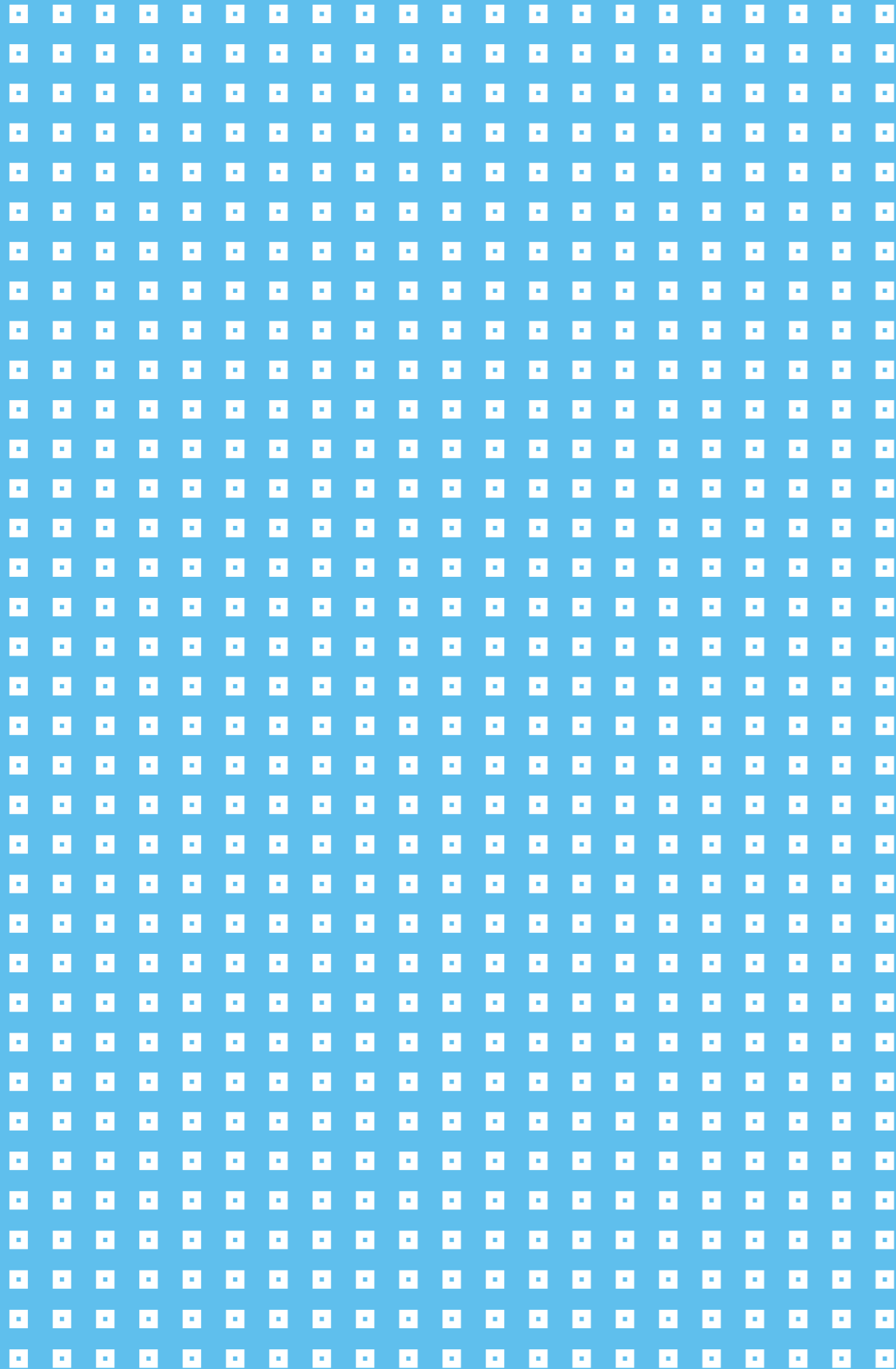

# SOLUCIONES LED

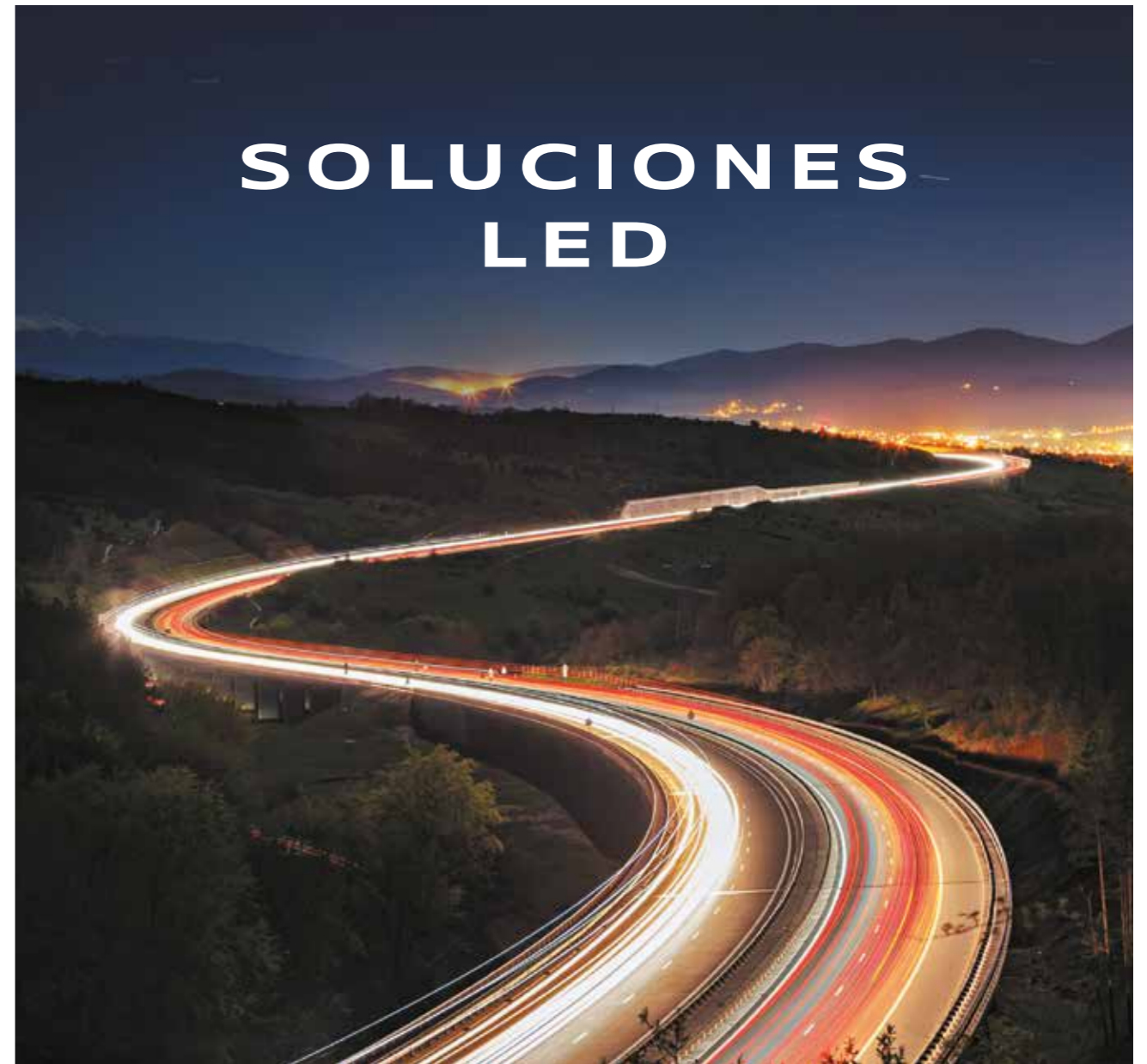

## RANGE PERFORMANCE LED



- HL [≈H1]
- HL [≈H3]
- HL [≈H4]
- HL [≈H7]
- HL [≈H11]
- FL [≈H8/H11/H16]
- HL [≈HB3/HB4]
- HL [≈HIR2]

Es su propia responsabilidad usar las luces LED retrofit conforme con los requisitos legales aplicables.



# LED

## 12/24V LÁMPARAS



Transforma tu coche de estándar a elegante en un solo paso con la hermosa nueva lámpara **LED NARVA Range Performance**.

Con luz blanca nítida y colores brillantes, no solo te verás bien, sino que verás más y reaccionaras más rápido.

## RANGE PERFORMANCE

Ilumine la carretera con faros blancos brillantes, lo que garantiza una gran visibilidad y una apariencia increíble. Debido a su tamaño compacto y diseño de "gire y ajuste", estas lámparas son una de las más fáciles de instalar. Con una resistencia térmica superior, las luces están protegidas del daño por calor, lo que las hace más duraderas.

El diseño óptico avanzado garantiza una conducción segura sin deslumbrar a los conductores en sentido contrario.



Halógena estándar



Range Performance LED

## INSTALACIÓN LÁMPARAS PRINCIPALES

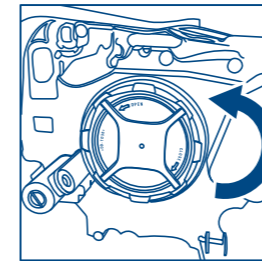

1 Retire la tapa del faro.

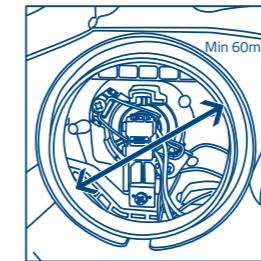

2 Asegúrese de que el diámetro interior es de al menos 60 mm.

Para tipos H1, H3 y H7

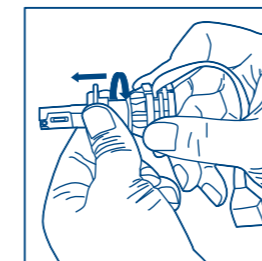

3 Retire el anillo central e instálelo en el soporte. Asegure el anillo con el clip metálico. Instale la lámpara en el soporte. Gire suavemente la lámpara para asegurarla.

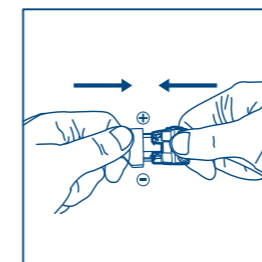
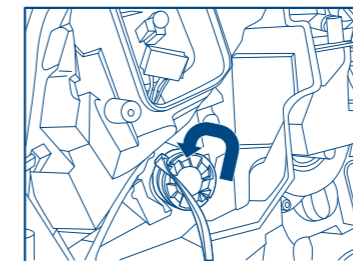

4 Conecte la bombilla al conector del automóvil (respetando polaridad para los tipos H1 y H3).

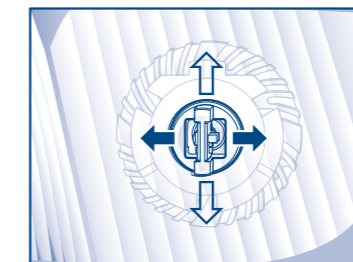

5 Asegúrese de que la superficie del LED esté posicionada verticalmente.

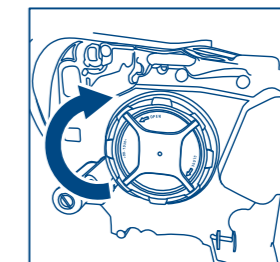

6 Cierre la tapa del faro.

# ¿QUÉ LED RETROFIT NECESITA?



## ILUMINACIÓN INTERIOR LUZ DE GUANTERA

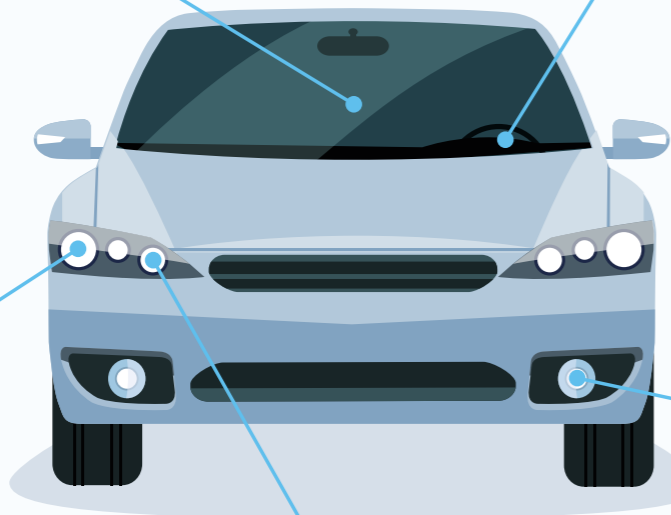

## LUCES DE SALPICADERO



## LUCES DE CARRETERA LUZ DE CRUCE



## LUCES DELANTERAS DE POSICIÓN



## LUCES DELANTERAS DE NIEBLA

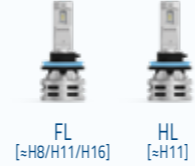

## TERCERA LUZ DE FRENADO



## LÁMPARA DE PLACA DE MATRICULACIÓN



## LUCES TRASERAS DE NIEBLA



## LUZ DEL MALETERO



## LUCES DE MARCHA ATRÁS











## LUCES DE FRENADO LUCES TRASERAS DE POSICIÓN



Es su propia responsabilidad usar las luces LED retrofit conforme con los requisitos legales aplicables.

## LÁMPARAS DELANTERAS

### RANGE PERFORMANCE

Tipo	Nº de ref.	V	W	Base	Piezas por unidad	Embalaje
 HL [≈H1]	0180573000	12/24	19	P14,5s	6	X2
 HL [≈H3]	0180583000	12/24	19	PK22s	6	X2
 HL [≈H4]	0180323000	12/24	24	P43t-38	6	X2
 HL [≈H7]	0180333000	12/24	24	PX26d	6	X2
 HL [≈H11]	0180483000	12/24	24	PGJ19-2	6	X2
 FL [≈H8/H11/H16]	0180363000	12/24	24	PGJ19-1	6	X2
 HL [≈HB3/HB4]	0180383000	12/24	24	P20d/P22d	6	X2
 HL [≈HIR2]	0180443000	12/24	24	PX22d	6	X2

  Es su propia responsabilidad usar las luces LED retrofit conforme con los requisitos legales aplicables.

## SEÑALIZACIÓN E ILUMINACIÓN DE INTERIOR

### RANGE PERFORMANCE

Tipo	Nº de ref.	V	W	Base	Piezas por unidad	Embalaje
 SL-WHITE [≈W5W]	0180744000	12	0.60	W2,1x9,5d	10	B2
 SL-WHITE [≈Fest 30 mm]	0180754000	12	0.60	SV8,5-8	10	B1
 SL-WHITE [≈Fest 38 mm]	0180794000	12	0.60	SV8,5-8	10	B1
 SL-WHITE [≈Fest 43 mm]	0180804000	12	0.60	SV8,5-8	10	B1
 SL-WHITE [≈P21W]	0180894000	12	1.75	BA15s	10	B2
 SL-RED [≈P21W]	0180934000	12	1.75	BA15s	10	B2
 SL-RED [≈P21/5W]	0180964000	12	0.80/1.75	BAY15d	10	B2
 SL-WHITE [≈W21W]	180134000	12	16	PGJ19-1/2/3	6	B2
 SL-RED [≈W21W]	180144000	12	16	P20d/P22d	6	B2
 SL-RED [≈W21/5W]	180154000	12	16	PX22D	6	B2



COCHE & CAMIÓN

LED

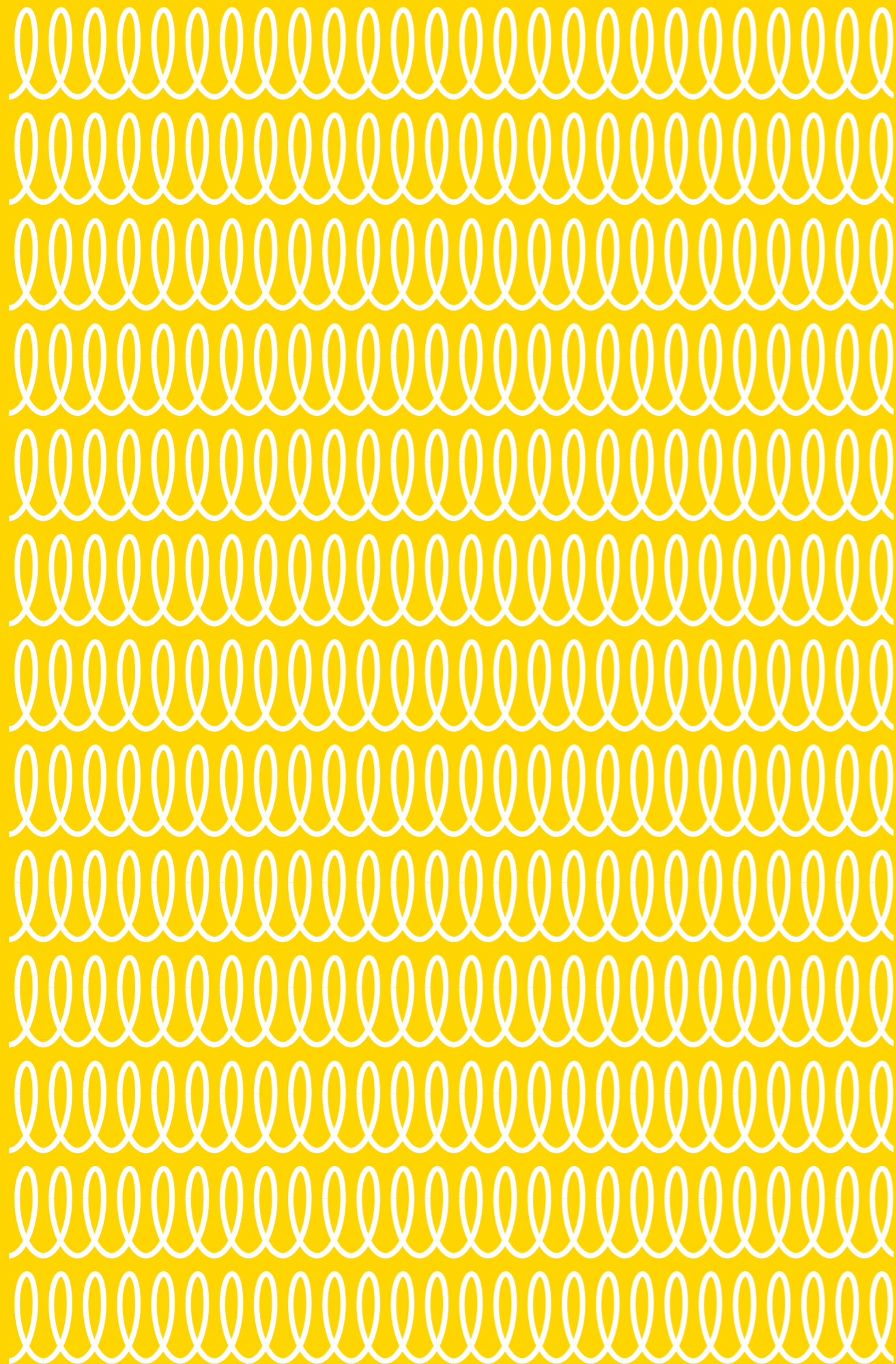

# SOLUCIONES HALÓGENAS

## COCHE

SUSTITUCIÓN	DURABILIDAD	MÁS VISIBILIDAD		ESTILO		
<b>Standard</b> Buena relación calidad-precio	<b>Long Life</b> Doble vida útil	<b>Range Power 50+</b> Hasta un 50% más visibilidad	<b>Range Power 150</b> Hasta un 150% más luminosidad	<b>Range Power Blue+</b> Hasta un 50% más visibilidad, elegante blanco	<b>Range Power White</b> 4 500 K de xenón blanco	<b>Rallye</b> Excelente luminosidad
						
					Sin homologación ECE*	Sin homologación ECE*

## CAMIÓN

SUSTITUCIÓN	DURABILIDAD	ESTILO
<b>Standard</b> Buena relación calidad-precio	<b>Heavy Duty</b> Resiste todas las vibraciones	<b>Rallye</b> Excelente luminosidad
		
		Sin homologación ECE*

\*Importante En Europa se prohíbe la venta de productos que no lleven el logotipo de certificación ECE y no estén homologados.



# SOLUCIONES HALÓGENAS



## SUSTITUCIÓN

### STANDARD

NARVA Standard es la gama estándar de NARVA. Representa la mejor relación calidad precio y combina fiabilidad y economía. Para conductores que busquen la mejor relación de calidad y rendimiento sin sacrificar la seguridad, NARVA Standard es la elección adecuada.



## DURABILIDAD

### LONG LIFE

Nuestra gama Long Life ha sido especialmente diseñada para una larga duración. Duran dos veces más que las lámparas estándar; no será preciso cambiar estas bombillas de larga duración con tanta frecuencia lo que implica un menor mantenimiento a la par que un mínimo impacto en el medioambiente.



## MÁS VISIBILIDAD

### RANGE POWER 50+



### RANGE POWER 50+

Con una visión hasta un 50% superior que una lámpara estándar, nuestra gama Range Power 50+ consigue un haz de luz más largo para un brillo aún mayor. Está diseñada para que los conductores vean más lejos y con más claridad para una mayor seguridad.



### RANGE POWER 150



### RANGE POWER 150

La nueva gama Range Power 150 ofrece hasta un 110% más luminosidad. El potente haz de luz permite a los conductores ver más lejos. El diseño especial de quemador genera una potencia lumínica más alta para una mayor seguridad y un rendimiento superior.



## ESTILO

### RANGE POWER BLUE+

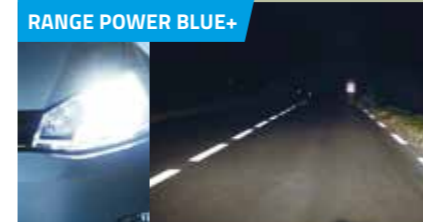

### RANGE POWER BLUE+

Emite hasta un 50% más visibilidad y hasta un 30% de elegante luz más fría. Nuestra gama Range Power Blue+ ha sido diseñada para que los conductores vean más lejos y con mayor claridad, para una mayor visibilidad y seguridad. El elegante efecto azul hará que cualquier coche destaque sobre los demás.



### RANGE POWER WHITE



### RANGE POWER WHITE\*

La gama Range Power White de NARVA proporciona una luz blanca brillante y elegante. Con el elegante efecto de xenón, conseguido gracias a la temperatura de color de 4 500 K, el automóvil adquiere un llamativo aspecto próximo a la luz diurna. Range Power White es la opción que elegida por los que desean destacar sobre los demás.



\*Sin homologación ECE.  
No se puede vender ni utilizar en Europa.

### RALLYE

### RALLYE\*

Ofreciendo alta potencia para una mayor visibilidad, la gama Rallye está diseñada para que los conductores vean más lejos y con mayor claridad.

\*Sin homologación ECE.  
No se puede vender ni utilizar en Europa.

















**NARVA** es reconocida por fabricar lámparas soluciones de iluminación halógenas de calidad duraderas y fiables.

Nuestras lámparas halógenas aportan mayor visibilidad y mayor seguridad en todas las condiciones de conducción.

### LÁMPARAS DELANTERAS











STANDARD

	ECE	Nº de ref.	V	W	Base	Piezas por unidad	Embalaje
	H1	483203000	12	55	P14,5s	100	C1
		483204000	12	55	P14,5s	10	B1
	H2	484203000	12	55	X511	100	C1
	H3	483213000	12	55	PK22s	100	C1
		483214000	12	55	PK22s	10	B1
	H4	488813000	12	60/55	P43t	100	C1
		488814000	12	60/55	P43t-38	10	B1
	H7	483283000	12	55	PX26d	100	C1
		483284000	12	55	PX26d	10	B1
	H8	480763000	12	55	PGJ19-1	100	C1
	H9	480773000	12	65	PGJ19-5	100	C1
	H10 (9145)	480953000	12	42	PY20d	100	C1
	H11	0480723000	12	55	PGJ19-2	100	C1
	H13 (9008)	480923000	12	60/55	P26,4t	100	C1



## LÁMPARAS DELANTERAS

STANDARD





	ECE	Nº de ref.	V	W	Base	Piezas por unidad	Embalaje
	H15	480703000	12	15/55	PGJ23t-1	100	C1
	HIR2	480673000	12	55	PX22d	100	C1
	R2 Halogen	481213000	12	45/40	P45t-41	100	C1
	R2	492113000	12	45/40	P45t	100	C1
	H27W/1	480413000	12	27	PG13	100	C1
	H27W/2	480423000	12	27	PG13	100	C1
	S2	495313000	12	35/35	BA20d	200	C1
	HB1	480043000	12	65/45	P29t	100	CP
	HB2	488823000	12	67/60	P43t-38	100	C1
	HB3	480053000 480054000	12 12	60 60	P20d P20d	100 10	C1 B1

	ECE	Nº de ref.	V	W	Base	Piezas por unidad	Embalaje
	HB4	480063000 480064000	12 12	51 51	P22d P22d	100 10	C1 B1

	ECE	Nº de ref.	V	W	Base	Piezas por unidad	Embalaje
	HB5	480073000	12	65/55	PX29t	100	C1

## LÁMPARAS DELANTERAS

LONG LIFE

	ECE	Nº de ref.	V	W	Base	Piezas por unidad	Embalaje
	H1 LL	483223000	12	55	P14,5s	100	C1
	H4 LL	488893000	12	60/55	P43t-38	100	C1
	H7 LL	483293000	12	55	PX26d	100	C1
	H11 LL	480783000	12	55	PGJ19-2	100	C1
	862 LL	480595000	12	37.5	PGJ13	300	CP







12V | COCHE |

HALÓGENAS







LÁMPARAS DELANTERAS

RANGE POWER 50+

	ECE	Nº de ref.	V	W	Base	Piezas por unidad	Embalaje
	H1	483343000	12	55	P14,5s	100	C1
	RP50+	483344000	12	55	P14,5s	10	B1
		483342100	12	55	P14,5s	10	S2
	H3	483353000	12	55	PK22s	100	C1
	RP50+						
	H4	488613000	12	60/55	P43t-38	100	C1
	RP50+	488614000	12	60/55	P43t-38	10	B1
		488612100	12	60/55	P43t-38	10	S2
	H7	483393000	12	55	PX26d	100	C1
	RP50+	483394000	12	55	PX26d	10	B1
		483392100	12	55	PX26d	10	S2

LÁMPARAS DELANTERAS

RANGE POWER 150

	ECE	Nº de ref.	V	W	Base	Piezas por unidad	Embalaje
	H1	480682100	12	55	P14,5s	10	S2
	RP150						
	H4	480692100	12	60/55	P43t-38	10	S2
	RP150						
	H7	480712100	12	55	PX26d	10	S2
	RP150						
	H11	481012100	12	55	PGJ19-2	10	S2
	RP150						

LÁMPARAS DELANTERAS

RANGE POWER BLUE+

	ECE	Nº de ref.	V	W	Base	Piezas por unidad	Embalaje
	H1	486303000	12	55	P14,5s	100	C1
	RPB+	486304000	12	55	P14,5s	10	B1
		486302100	12	55	P14,5s	10	S2
	H3	486333000	12	55	PK22s	100	C1
	RPB+						
	H4	486773000	12	60/55	P43t-38	100	C1
	RPB+	486774000	12	60/55	P43t-38	10	B1
		486772100	12	60/55	P43t-38	10	S2
	H7	486383000	12	55	PX26d	100	C1
	RPB+	486384000	12	55	PX26d	10	B1
		486382100	12	55	PX26d	10	S2
	HB2	486763000	12	67/60	P43t-38	100	C1
	RPB+						
	HB3	486163000	12	60	P20d	100	C1
	RPB+						
	HB4	486133000	12	51	P22d	100	C1
	RPB+						
	HB5	486293000	12	65/55	PX29t	100	C1
	RPB+						











12V | COCHE

HALÓGENAS

LÁMPARAS DELANTERAS









RANGE POWER WHITE\*

Tipo	Nº de ref.	V	W	Base	Piezas por unidad	Embalaje
 H1 RPW	486412100	12	55	P14,5s	10	S2
 H3 RPW	486022100	12	55	PK22s	10	S2
 H4 RPW	486802100	12	60/55	P43t-38	10	S2
 H7 RPW	486072100	12	55	PX26d	10	S2
 HB3 (9005) RPW	486252100	12	65	P20d	10	S2
 HB4 (9006) RPW	486262100	12	55	P22d	10	S2
 H1/W5W PW kit	980142100	H1 W5W	85 5	P14,5s W2,1x9,5d	2 2	SM
 H4/W5W PW kit	980152100	H4 W5W	100/90 5	P43t W2,1x9,5d	2 2	SM
 H7/W5W PW kit	980162100	H7 W5W	85 5	PX26d W2,1x9,5d	2 2	SM

\*Importante Los productos que no llevan el logo de certificación ECE no están homologados y no pueden venderse en Europa.

LÁMPARAS DELANTERAS

RALLYE\*











Tipo	Nº de ref.	V	W	Base	Piezas por unidad	Embalaje
 H1 Rallye	483503000 483803000	12 12	100 130	P14,5s P14,5s	100 100	C1 C1
 H3 Rallye	483513000 483813000	12 12	100 130	PK22s PK22s	100 100	C1 C1
 H4 Rallye	489013000 489014000 489113000 489513000	12 12 12 12	100/90 100/90 100/55 130/100	P43t-38 P43t-38 PX26d P43t	100 10 100 100	C1 B1 C1 C1
 H4 Rallye	488843000 489043000	12 12	60/55 100/90	P45t P45t-41	100 100	C1 C1
 H7 Rallye	483583000	12	80	PX26d	100	C1
 HB1 Rallye	480343000	12	100/80	P29t	100	C1
 HB3 Rallye	480253000	12	100	P20d	100	C1
 HB4 Rallye	480263000	12	70	P22d	100	C1
 HB5 Rallye	480313000	12	100/80	PX29t	100	C1







\*Importante Los productos que no llevan el logo de certificación ECE no están homologados y no pueden venderse en Europa.



# LÁMPARAS DELANTERAS

## TIPOS AMERICANOS

Tipo AM.	Nº de ref.	V	W	Base	Piezas por unidad	Embalaje
 9004 (HB1)	480043000	12	65/45	P29t	100	CP
 9003 (HB2)	488823000	12	67/60	P43t-38	100	C1
 9005 (HB3)	480053000 480054000	12 12	60 60	P20d P20d	100 10	C1 B1
 9006 (HB1)	480063000 480064000	12 12	51 51	P22d P22d	100 10	C1 B1
 9007 (HB5)	480073000	12	65/45	PX29t	100	C1
 9008 (H13)	480923000	12	60/55	P26,4t	100	C1
 9145 (H10)	480953000	12	42	Y20d	100	C1
 880	480393000	12.8	27	PG13	100	C1
 881	480403000	12.8	27	PGJ13	100	C1
 885	480553000	12.8	50	PG13	100	C1

Tipo AM.	Nº de ref.	V	W	Base	Piezas por unidad	Embalaje
 886	480563000	12.8	50	PGJ13	100	C1
 889	480453000	12.8	27	PGJ13	100	C1
 890	480463000	12.8	27	PG13	100	C1
 893	480513000	12.8	37.5	PG13	100	C1
 894	480543000	12.8	37.5	PGJ13	100	C1
 896	480523000	12.8	37.5	PGJ13	100	C1



12V | COCHE |





HALÓGENAS















## SEÑALIZACIÓN E ILUMINACIÓN DE INTERIOR

### STANDARD

	ECE	Nº de ref.	V	W	Base	Piezas por unidad	Embalaje
	(Stop P22)	174113000	12	15	BA15s	200	CP
	(Stop P25) BA15s	175113000	12	18	BA15s	200	CP
	P21W	176353000	12	21	BA15s	200	CP
		176354000	12	21	BA15s	10	B2
		176403000	12	21	BAU15s	200	CP
	PY21W Amber	176383000	12	21	BAU15s	200	CP
		176384000	12	21	BAU15s	10	B2

	ECE	Nº de ref.	V	W	Base	Piezas por unidad	Embalaje
	P21/4W	178813000	12	21/4	BAZ15d	200	CP
		178814000	12	21/4	PX26d	10	B2
	P21/5W	179163000	12	21/5	BAY15d	200	CP
		179164000	12	21/5	BAY15d	10	B2
	(Stop P25) BA15d	179183000	12	21/5	BA15d	200	CP
	R5W BA15s	171713000	12	5	BA15s	200	CP
		171714000	12	5	BA15s	10	B2
	R5W BA15d	171723000	12	5	BA15d	200	CP
	R10W	173113000	12	10	BA15s	200	CP
		173114000	12	10	BA15s	10	B2
	RY10W	173173000	12	10	BAU15s	200	CP
		170513000	12	2	BA7s	200	CP
		170533000	12	2	BA9s	200	CP
	T4W	171313000	12	4	BA9s	200	CP





SEÑALIZACIÓN E ILUMINACIÓN DE INTERIOR

LÁMPARAS HALÓGENAS EN MINIATURA

ECE	Nº de ref.	V	W	Base	Piezas por unidad	Embalaje
(H5W)	178303000	12	5	BA9s	200	CP
H6W	681613000	12	6	BAX9s	200	CP
(H10W)	178333000	12	10	BA9s	200	CP
(H20W)	178353000	12	20	BA9s	200	CP
H21W	681913000	12	21	BAY9s	200	CP

SEÑALIZACIÓN E ILUMINACIÓN DE INTERIOR

LÁMPARAS INDICADORAS DE BASE EN CUÑA

ECE	Nº de ref.	V	W	Base	Piezas por unidad	Embalaje
(W1,2W) Frosted	170323000	12	1.2	W2x4,6d	200	CP
(W1,2W)	170373000	12	1.2	W2x4,6d	200	CP
(W2,2W)	170593000	12	2.2	W2,1x9,5d	200	CP
W2,3W	170733000	12	2.3	W2x4,6d	200	CP

ECE	Nº de ref.	V	W	Base	Piezas por unidad	Embalaje
W3W	170973000	12	3	W2,1x9,5d	200	CP
W5W	171773000 171774000	12 12	5 5	W2,1x9,5d W2,1x9,5d	200 10	CP B2
WY5W	171693000	12	5	W2,1x9,5d	200	CP
W16W	176313000	12	16	W2,1x9,5d	200	CP
W21W	176323000	12	21	W3x16d	200	CP
WY21W	176293000	12	21	WX3x16d	200	CP
W21/5W	179193000	12	21/5	W3x16q	200	CP

SEÑALIZACIÓN E ILUMINACIÓN DE INTERIOR

LÁMPARAS FESTOON

ECE	Nº de ref.	V	W	Base	Piezas por unidad	Embalaje
T8.2x30	170943000	12	3	SV7,5	200	CP
C5W	171253000 171254000	12 12	5 5	SV8,5 SV8,5	200 10	CP B2





	ECE	Nº de ref.	V	W	Base	Piezas por unidad	Embalaje
	<b>T10.5x43</b>	<b>171753000</b>	12	5	SV8,5	200	CP

	ECE	Nº de ref.	V	W	Base	Piezas por unidad	Embalaje
	<b>T10.5x43</b>	<b>173143000</b>	12	10	SV8,5	200	CP

	ECE	Nº de ref.	V	W	Base	Piezas por unidad	Embalaje
	<b>T10.5x30</b>	<b>173153000</b>	12	10	SV8,5	200	CP

	ECE	Nº de ref.	V	W	Base	Piezas por unidad	Embalaje
	<b>T10.5x38</b>	<b>173163000</b>	12	10	SV8,5	200	CP

	ECE	Nº de ref.	V	W	Base	Piezas por unidad	Embalaje
	<b>T15x43</b>	<b>175123000</b>	12	18	SV8,5	200	CP

	ECE	Nº de ref.	V	W	Base	Piezas por unidad	Embalaje
	<b>C21W</b>	<b>176343000</b>	12	21	SV8,5	200	CP

## SEÑALIZACIÓN E ILUMINACIÓN DE INTERIOR

## LÁMPARAS CON BASE PLÁSTICA (BAX)

	ECE	Nº de ref.	V	W	Base	Piezas por unidad	Embalaje
		<b>170063000</b>	12	0.4	Bax 8,5d blue violet	200	CP

	ECE	Nº de ref.	V	W	Base	Piezas por unidad	Embalaje
		<b>170193000</b>	12	1	Bax 8,5d orange	200	CP

	ECE	Nº de ref.	V	W	Base	Piezas por unidad	Embalaje
		<b>170273000</b>	12	1.2	Bax 8,4d light blue	200	CP

	ECE	Nº de ref.	V	W	Base	Piezas por unidad	Embalaje
		<b>170283000</b>	12	1.2	Bax 8,4d black	200	CP

	ECE	Nº de ref.	V	W	Base	Piezas por unidad	Embalaje
		<b>170293000</b>	12	1.2	Bax 8,5d blue	200	CP

	ECE	Nº de ref.	V	W	Base	Piezas por unidad	Embalaje
		<b>170353000</b>	12	1.2	Bax 8,5d black	200	CP

	ECE	Nº de ref.	V	W	Base	Piezas por unidad	Embalaje
		<b>170363000</b>	12	1.2	Bax 8,3d black	200	CP

	ECE	Nº de ref.	V	W	Base	Piezas por unidad	Embalaje
		<b>170463000</b>	12	1.1	Bax 8,4d orange	200	CP

	ECE	Nº de ref.	V	W	Base	Piezas por unidad	Embalaje
		<b>170473000</b>	12	1.3	Bax 8,4d olive green	200	CP





	ECE	Nº de ref.	V	W	Base	Piezas por unidad	Embalaje
		<b>170483000</b>	12	1.5	Bax 8,4d beige	200	CP

	ECE	Nº de ref.	V	W	Base	Piezas por unidad	Embalaje
		<b>170493000</b>	12	1.5	Bax 8,5d beige	200	CP

	ECE	Nº de ref.	V	W	Base	Piezas por unidad	Embalaje
		<b>170503000</b>	12	1.5	Bax 8,5d yellow	200	CP



	ECE	Nº de ref.	V	W	Base	Piezas por unidad	Embalaje
		<b>170523000</b>	12	2	Bax 8,5d light green	200	CP



	ECE	Nº de ref.	V	W	Base	Piezas por unidad	Embalaje
		170543000	12	2	Bax 8,4d light green	200	CP
		170573000	12	2	Bax 8,5d green	200	CP
		170583000	12	2	Bax 8,3d blue	200	CP
		170603000	12	1.8	Bax 8,4d beige	200	CP
		171633000	12	5	Bax 10d black	100	C1



## SEÑALIZACIÓN E ILUMINACIÓN DE INTERIOR

### RANGE POWER BLUE+

	ECE	Nº de ref.	V	W	Base	Piezas por unidad	Embalaje
	<b>W5W RPB+</b>	171893000	12	5	W2,1x9,5d	200	CP
	<b>H6W RPB+</b>	681633000	12	6	BAX9s	200	CP

## SEÑALIZACIÓN E ILUMINACIÓN DE INTERIOR

### TIPOS AMERICANOS

	Tipo AM.	Nº de ref.	V	W	Base	Piezas por unidad	Embalaje
	<b>3156</b>	179413000	12.8	32CP	W2,5x16d	200	CP
	<b>3157</b>	179453000	12.8/14	32/3CP	W2,5x16q	200	CP
	<b>3157 NA</b>	179483000	12.8/14	24/2.2CP	W2,5x16q	200	CP







## KITS DE REPUESTOS



## STANDARD

En muchos países europeos están recomendados los kits de repuestos y en países como Francia son obligatorios. Nuestros kits de repuesto proporcionan a los conductores la seguridad que necesitan mientras viajan por carretera.

Descripción	Nº de ref.	Contenido	W	Base	Nº de piezas	
 Mini kit de repuestos H4	980043010	H4	60/55	P43t	1	
		P21W	21	BA15s	1	
		R5W	5	BA15s	1	
		W5W	5	W2,1x9,5d	1	
		Flat fuse			2	
		<b>Cantidad de embalaje</b>				<b>20</b>
 Kit de repuestos H4	984003010	H4	60/55	P43t	1	
		P21/5W	21/5	BAY15d	1	
		P21W	21	BA15s	1	
		R5W	5	BA15s	1	
		C5W	5	SV8,5	1	
		W5W	5	W2,1x9,5d	1	
		Flat fuse			4	
		<b>Cantidad de embalaje</b>				<b>20</b>
 Kit de repuestos H7/H1	984353010	H7	55	PX26d	1	
		17	55	P14,5s	1	
		P21/5W	21/5	BAY15d	1	
		P21W	21	BA15s	1	
		PY21W	21	BAU15s	1	
		C5W	5	SV8,5	1	
		W5W	5	W2,1x9,5d	1	
		Flat fuse			4	
		<b>Cantidad de embalaje</b>				<b>20</b>

## KITS DE REPUESTOS

## RANGE POWER WHITE\*

Descripción	Nº de ref.	Contenido	W	Base	Nº de piezas
 Kit RPW H1/W5W	980142100	H1	85	P14,5s	2
		W5W	5	W2,1x9,5d	2
		<b>Cantidad de embalaje</b>			
 Kit RPW H1/W5W	980152100	H4	100/90	P43t	2
		W5W	5	W2,1x9,5d	2
		<b>Cantidad de embalaje</b>			
 Kit RPW H7/W5W	980162100	H7	85	P14,5s	2
		W5W	5	W2,1x9,5d	2
		<b>Cantidad de embalaje</b>			

\*Importante En Europa se prohíbe la venta de productos que no lleven el logotipo de certificación ECE y no estén homologados.

## HERRAMIENTAS DE VENTAS

	<b>Expositor de mostrador</b> <b>GOC: 98027700</b> Se entrega con <ul style="list-style-type: none"> <li>20x H7 estándar C1</li> <li>10x H4 estándar C1</li> </ul>		<b>Floor display</b> <b>GOC: 99026700</b> Expositor para suelo de cartón resistente se entrega vacío. <ul style="list-style-type: none"> <li>12 ganchos</li> <li>Cartel intercambiable</li> </ul>	
	<b>Dispensador para pared 12V</b> <b>GOC (vacío): 980173000</b> <b>GOC (lleno): 980223000</b> Se entrega vacío o lleno de lámparas (ver composición a continuación). Carcasa metálica resistente Tamaño compacto: 37 x 17.6 x 59.5 cm Se puede cerrar con llave Se entrega con <table border="0"> <tr> <td> <ul style="list-style-type: none"> <li>10x H1</li> <li>10x H3</li> <li>30x H4</li> <li>50x H7</li> <li>30x P21/5W</li> </ul> </td> <td> <ul style="list-style-type: none"> <li>30x P21W</li> <li>30x R5W BA15</li> <li>30x R10W</li> <li>30x T4W</li> <li>30x C5W</li> </ul> </td> <td> <ul style="list-style-type: none"> <li>20x Fest T10,5x43</li> <li>20x W1,2W</li> <li>20x W3W</li> <li>30x W5W</li> </ul> </td> </tr> </table>		<ul style="list-style-type: none"> <li>10x H1</li> <li>10x H3</li> <li>30x H4</li> <li>50x H7</li> <li>30x P21/5W</li> </ul>	<ul style="list-style-type: none"> <li>30x P21W</li> <li>30x R5W BA15</li> <li>30x R10W</li> <li>30x T4W</li> <li>30x C5W</li> </ul>
<ul style="list-style-type: none"> <li>10x H1</li> <li>10x H3</li> <li>30x H4</li> <li>50x H7</li> <li>30x P21/5W</li> </ul>	<ul style="list-style-type: none"> <li>30x P21W</li> <li>30x R5W BA15</li> <li>30x R10W</li> <li>30x T4W</li> <li>30x C5W</li> </ul>	<ul style="list-style-type: none"> <li>20x Fest T10,5x43</li> <li>20x W1,2W</li> <li>20x W3W</li> <li>30x W5W</li> </ul>		

# CAMIÓN

## 24V LÁMPARAS



Combinando resistencia a la vibración con alta calidad, nuestras gamas de iluminación de 24V son robustas y fiables para los camiones y otros vehículos pesados de hoy.

LÁMPARAS DELANTERAS de camión **NARVA** cuentan con resistencia a vibraciones y calidad superior.

Consulte nuestra gama de 24 V cuando se requiera mayor resistencia y durabilidad.

## ¿QUÉ TIPO DE LÁMPARA DE 24V NECESITA?

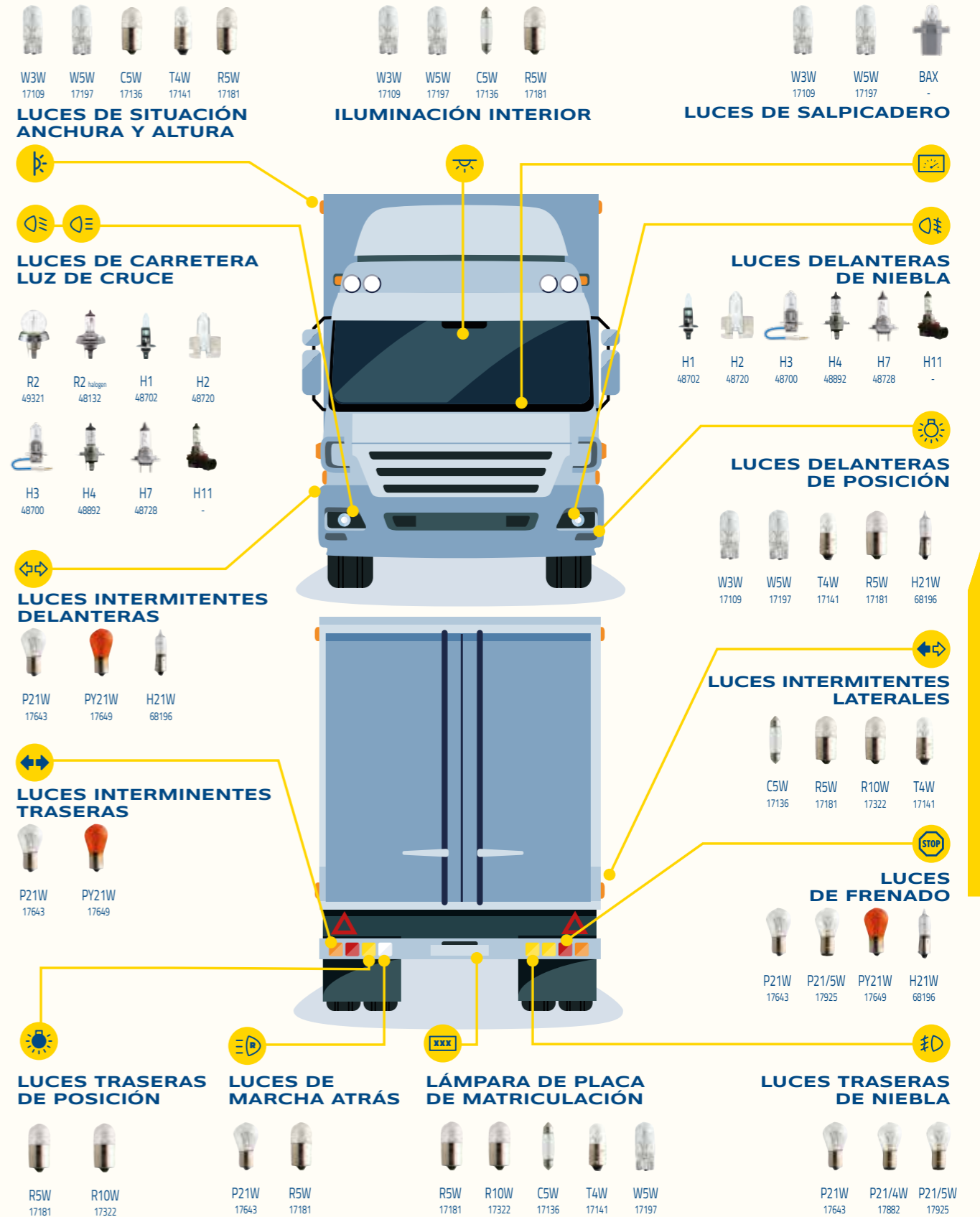

24V | CAMIÓN |

HALÓGENAS





LÁMPARAS DELANTERAS

STANDARD

	ECE	Nº de ref.	V	W	Base	Piezas por unidad	Embalaje
	H1	487023000	24	70	P14,5s	100	C1
		487024000	24	70	P14,5s	10	B1
	H2	487203000	24	70	X511	100	C1
	H3	487003000	24	70	PK22s	100	C1
	H4	488923000	24	75/70	P43t	100	C1
		488924000	24	75/70	P43t-38	10	B1
	H7	487283000	24	70	PX26d	100	C1
		487284000	24	70	PX26d	10	B1
	R2 Halogen	481323000	24	55/50	P45t-41	100	C1
	R2	493213000	24	55/50	P45t	100	C1





LÁMPARAS DELANTERAS

HEAVY DUTY

	ECE	Nº de ref.	V	W	Base	Piezas por unidad	Embalaje
	H1 HD	487083000	24	70	P14,5s	100	C1
	H3 HD	487093000	24	70	PK22s	100	C1
	H4 HD	488983000	24	75/70	P43t-38	100	C1
	H7 HD	487293000	24	70	PX26d	100	C1

LÁMPARAS DELANTERAS

RALLYE\*











	Tipo	Nº de ref.	V	W	Base	Piezas por unidad	Embalaje
	H1 Rallye	483503000	12	100	P14,5s	100	C1
		483803000	12	130	P14,5s	100	C1
	H3 Rallye	483513000	12	100	PK22s	100	C1
		483813000	12	130	PK22s	100	C1
	H4 Rallye	489013000	12	100/90	P43t-38	100	C1
		489014000	12	100/90	P43t-38	10	B1
		489113000	12	100/55	PX26d	100	C1
		489513000	12	130/100	P43t	100	C1
	H4 Rallye P45t	488843000	12	60/55	P45t	100	C1
		489043000	12	100/90	P45t-41	100	C1

\*Importante En Europa se prohíbe la venta de productos que no lleven el logotipo de certificación ECE y no estén homologados.



## SEÑALIZACIÓN E ILUMINACIÓN DE INTERIOR

STANDARD

	ECE	Nº de ref.	V	W	Base	Piezas por unidad	Embalaje
		179273000	24	21/5	BA15d	200	CP
	P21W	176433000 176434000	24	21	BA15s BA15s	200 10	CP B2
	P21/4W	178823000	24	21/4	BAZ15d	200	CP
	P21/5W	179253000	24	21/5	BAY15d	200	CP
	Stop P22	174213000	24	15	BA15s	200	CP
	R5W BA15s	171813000 171814000	24	5	BA15s BA15s	200 10	CP B2
	R5W	171823000	24	5	BA15d	200	CP
	R10W	173223000	24	10	BA15d	200	CP
		170613000	24	3	BA7s	200	CP
		170633000	24	2	BA9s	200	CP



ECE	Nº de ref.	V	W	Base	Piezas por unidad	Embalaje
T4W	171413000	24	4	BA9s	200	CP

## SEÑALIZACIÓN E ILUMINACIÓN DE INTERIOR

LÁMPARAS HALÓGENAS EN MINIATURA



ECE	Nº de ref.	V	W	Base	Piezas por unidad	Embalaje
H21W	681963000	24	21	BAY9s	200	CP





HALÓGENAS

24V | CAMIÓN





SEÑALIZACIÓN E ILUMINACIÓN DE INTERIOR

LÁMPARAS INDICADORAS DE BASE EN CUÑA

	ECE	Nº de ref.	V	W	Base	Piezas por unidad	Embalaje
	(W1,2W)	170403000	24	1.2	W2x4,6d	200	CP
	W3W	171093000	24	3	W2,1x9,5d	200	CP
	W5W	171973000	24	5	W2,1x9,5d	200	CP











SEÑALIZACIÓN E ILUMINACIÓN DE INTERIOR

LÁMPARAS FESTOON

	ECE	Nº de ref.	V	W	Base	Piezas por unidad	Embalaje
	T8.2x30	171043000	24	3	SV7,5	200	CP
	C5W	171363000	24	5	SV8,5	200	CP
	T10.5x43	171853000	24	5	SV8,5	200	CP
	T10.5x43	173273000	24	10	SV8,5	200	CP
	T15x43	175223000	24	18	SV8,5	200	CP

SEÑALIZACIÓN E ILUMINACIÓN DE INTERIOR

LÁMPARAS CON BASE PLÁSTICA (BAX)





	ECE	Nº de ref.	V	W	Base	Piezas por unidad	Embalaje
		170223000	24	1.2	EBS-R4 yellow	200	CP
		170383000	24	1.2	Bax 8,3d grey	200	CP
		170393000	24	1.2	Bax 8,5d grey	200	CP
		170673000	24	1.8	Bax 8,4d blue	200	CP
		170763000	24	1.2	Bax 8,5d brown	200	CP
		170813000	24	1.4	REF29 white	200	CP
		170823000	24	1.4	Bax 8,4d light green	200	CP
		171023000	24	1.2	EBS-R6 brown	200	CP
		171033000	24	1.2	EBS-R white 1,25 mm FR	200	CP
		170723000	24	1.2	EBS-R white frosted	200	CP



24V | CAMIÓN

HALÓGENAS



	ECE	Nº de ref.	V	W	Base	Piezas por unidad	Embalaje
	P21W HD	176443000	24	21	BA15s	200	CP
	PY21W HD	176493000	24	21	BAU15s	200	CP
	T4W HD	171433000	24	4	BA9s	200	CP
	R5W HD	171863000	24	5	BA15s	200	CP
	R10W HD	173283000	24	10	BA15s	200	CP

## KITS DE REPUESTOS

En muchos países europeos están recomendados los kits de repuestos y en países como Francia son obligatorios. NARVA ha diseñado sus kits de repuestos para que los conductores puedan cambiar las lámparas fundidas de un modo rápido y fácil.

	Descripción	Nº de ref.	Contenido	W	Base	Nº de piezas			
	Kit de repuestos H4	986143010	H4	75/70	P43t	2			
			P21W	21	BA15s	6			
			R10W	10	BA15s	2			
			C10W	10	SV8,5	2			
			W5W	5	W2,1x9,5d	2			
			Flat fuse			8			
			Cantidad de embalaje						20
				Kit de repuestos H7	986303010	H7	70	PX26d	2
P21W	21	BA15s				4			
PY21W	21	BA15s				2			
R10W	10	BA15s				2			
C10W	10	SV8,5				2			
W5W	5	W2,1x9,5d				2			
Flat fuse						3			
Cantidad de embalaje						20			

## HERRAMIENTAS DE VENTAS

Dispensador para pared	
GOC (vacío): 990287000	GOC (lleno): 980173000
Se entrega lleno de lámparas (ver composición a continuación).	
Carcasa metálica resistente	
Tamaño compacto: 37 x 17.6 x 59.5 cm	
Se puede cerrar con llave	
Se entrega con	
<ul style="list-style-type: none"> <li>▪ 15x H1</li> <li>▪ 15x H3</li> <li>▪ 10x H4</li> <li>▪ 20x H7</li> <li>▪ 10x P21W</li> </ul>	<ul style="list-style-type: none"> <li>▪ 10x PY21W HD</li> <li>▪ 10x R5W</li> <li>▪ 10x R10W</li> <li>▪ 10x T4W</li> <li>▪ 10x W3W</li> </ul>
<ul style="list-style-type: none"> <li>▪ 10x W5W</li> <li>▪ 10x W12W</li> <li>▪ 10x C5W</li> </ul>	

# DOS RUEDAS

## 12V LÁMPARAS



**NARVA** ofrece una iluminación para motocicletas perfecta para las condiciones de tráfico exigentes de hoy en día. Nuestras lámparas para motocicletas ofrecen la visibilidad y la seguridad que los motoristas necesitan.

## ¿QUÉ TIPO DE LÁMPARA PARA VEHÍCULOS DE DOS RUEDAS NECESITA?

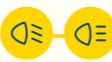

**LUCES DE CRUCE**  
**LUCES DE CARRETERA**



**LUCES INTERMITENTES DELANTERAS**



**LUCES TRASERAS DE POSICIÓN**

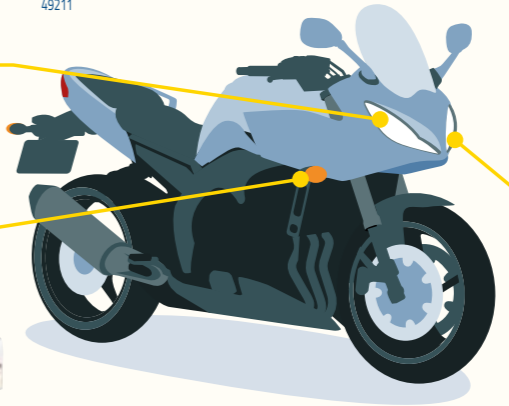

**LUCES DELANTERAS DE POSICIÓN**



**LUCES DE FRENADO**



**LÁMPARA DE PLACA DE MATRICULACIÓN**



LÁMPARAS DELANTERAS

STANDARD

	ECE HS1	Nº de ref. 482203000	V 12	W 35/35	Base PX43t	Piezas por unidad 100	Embalaje C1
	ECE H3	Nº de ref. 483013000	V 6	W 55	Base PK22s	Piezas por unidad 100	Embalaje C1
	ECE H4 Rallye	Nº de ref. 482223000	V 12	W 35/35	Base P43t-38	Piezas por unidad 100	Embalaje C1
	ECE S3	Nº de ref. 490143000 490043000	V 12 6	W 15 15	Base P26s P26s	Piezas por unidad 200 200	Embalaje CP CP
	ECE (M5) P15d-25-1	Nº de ref. 420073000 420053000 420013000	V 12 12 12	W 35/35 25/25 18/18	Base P15d-25-1 P15d-25-1 P15d-25-1	Piezas por unidad 100 100 100	Embalaje C1 C1 C1
	ECE (M5) P15d-25-3	Nº de ref. 420173000 420153000	V 12 12	W 35/35 25/25	Base P15d-25-3 P15d-25-3	Piezas por unidad 100 100	Embalaje C1 C1
	ECE (M5) BA20d	Nº de ref. 420273000 420253000	V 12 12	W 35/35 25/25	Base BA20d BA20d	Piezas por unidad 100 100	Embalaje C1 C1

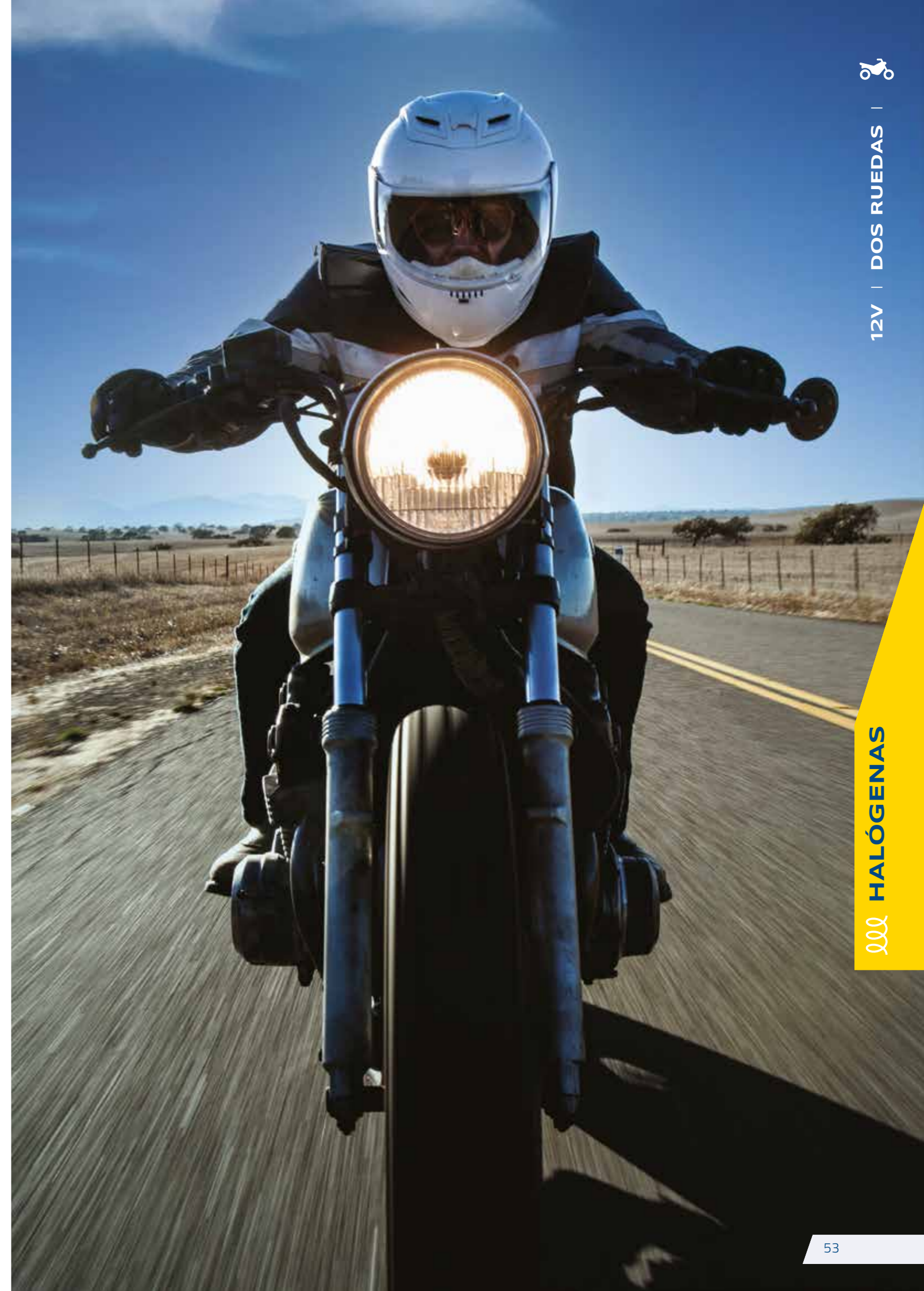

12V | DOS RUEDAS |

HALÓGENAS

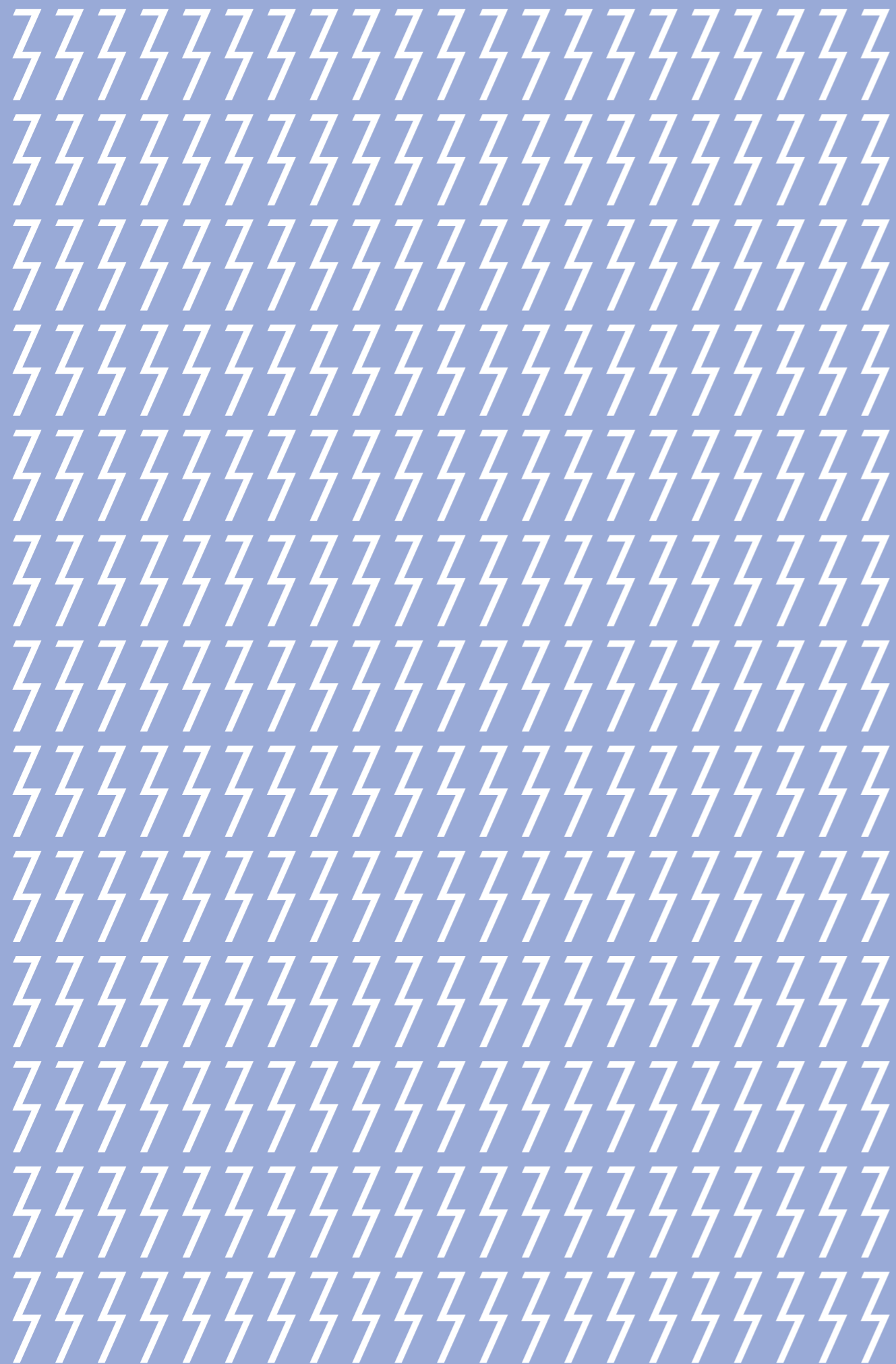

# SOLUCIONES XENÓN



COCHE Y CAMIÓN



- D1S
- D1R
- D2S
- D2R
- D3S
- D3R
- D4S



## ¿QUÉ TIPO DE LÁMPARA NECESITA?









LUCES DE CRUCE  
LUCES DE CARRETERA



D1S   D1R   D2S   D2R   D3S   D4S

Produciendo una luz blanca brillante y un haz preciso, la gama **NARVA** xenon ofrece una mayor visibilidad para una mayor seguridad.

La tecnología de xenón **NARVA** significa una larga vida útil y una luz brillante en la carretera. Con un cristal de cuarzo especial que bloquea los rayos UV, esta solución de iluminación proporciona gran visibilidad y máxima seguridad al permitir a los conductores ver aún más lejos.

	ECE <b>D1S</b>	Nº de ref. <b>840103000</b>	V <b>85</b>	W <b>35</b>	Base <b>PK32d-2</b>	Piezas por unidad <b>2</b>	Embalaje <b>C1</b>
	ECE <b>D1R</b>	Nº de ref. <b>840113000</b>	V <b>85</b>	W <b>35</b>	Base <b>PK32d-3</b>	Piezas por unidad <b>2</b>	Embalaje <b>C1</b>
	ECE <b>D2S</b>	Nº de ref. <b>840023000</b>	V <b>85</b>	W <b>35</b>	Base <b>P32d-2</b>	Piezas por unidad <b>2</b>	Embalaje <b>C1</b>
	ECE <b>D2R</b>	Nº de ref. <b>840063000</b>	V <b>85</b>	W <b>35</b>	Base <b>P32d-3</b>	Piezas por unidad <b>2</b>	Embalaje <b>C1</b>
	ECE <b>D3S</b>	Nº de ref. <b>840323000</b>	V <b>42</b>	W <b>35</b>	Base <b>PK32d-5</b>	Piezas por unidad <b>2</b>	Embalaje <b>C1</b>
	ECE <b>D4S</b>	Nº de ref. <b>840423000</b>	V <b>42</b>	W <b>35</b>	Base <b>P32d-5</b>	Piezas por unidad <b>2</b>	Embalaje <b>C1</b>

## INFORMACIÓN SOBRE SISTEMAS DE ILUMINACIÓN DE XENÓN

### Principales ventajas

- / Proyección de luz brillante y potente en la carretera
- / Intensidad y color de la luz próximas a la luz diurna
- / Duración extralarga
- / Bajo consumo energético



Una lámpara Xenon HID  
(Descarga de alta intensidad)

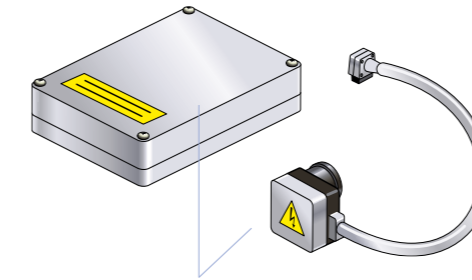

Balasto electrónico  
y arranque de alto voltaje



Complejo sistema óptico  
con control de nivel automático y  
sistema de lavado electrónico

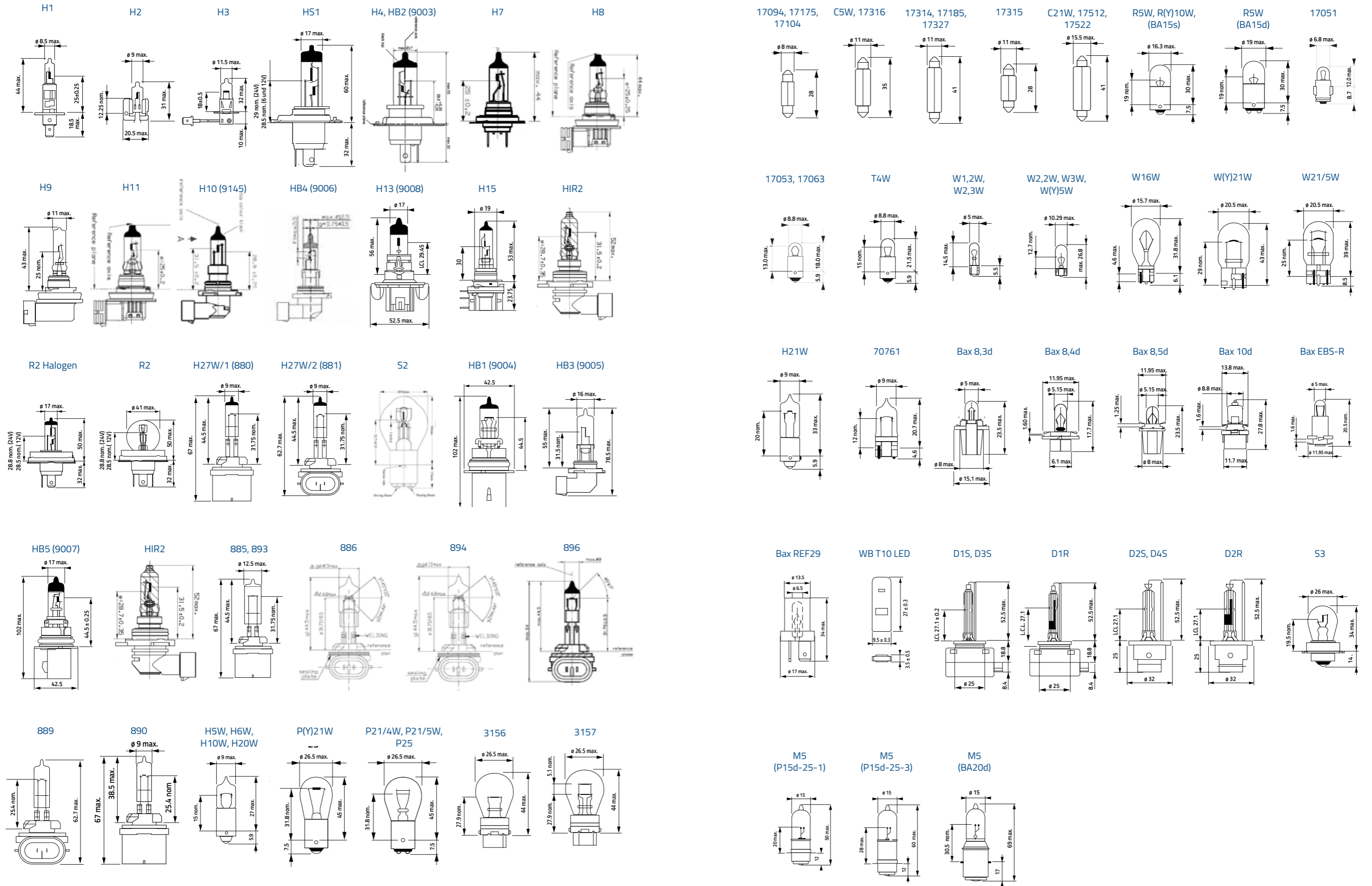

# CASQUILLOS (IEC 60061-1)

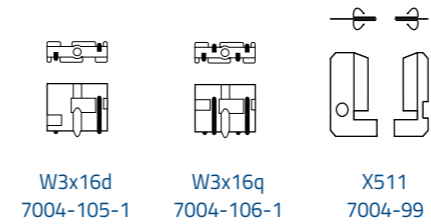
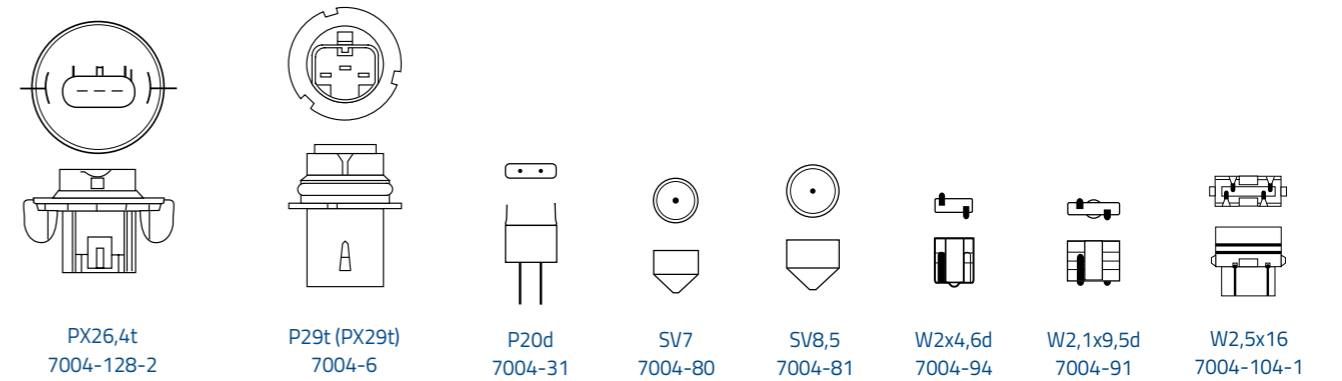
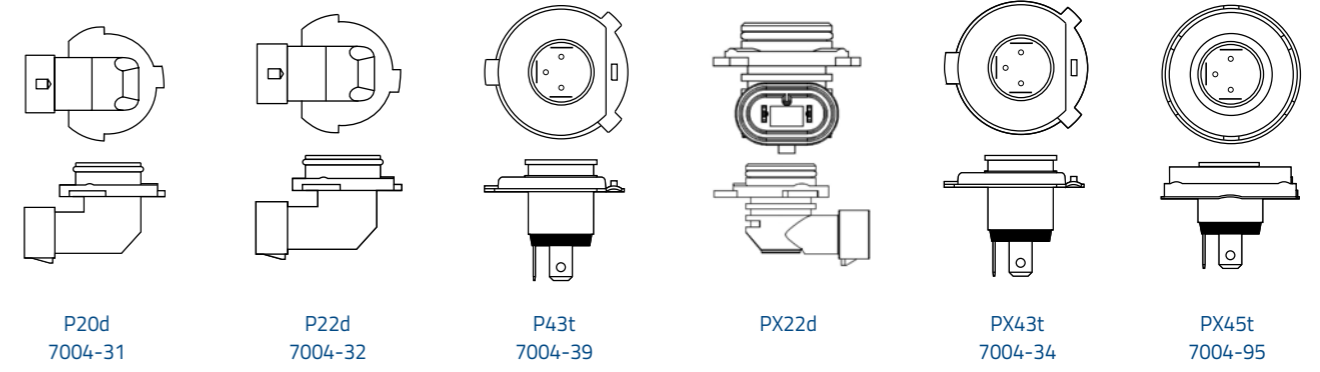
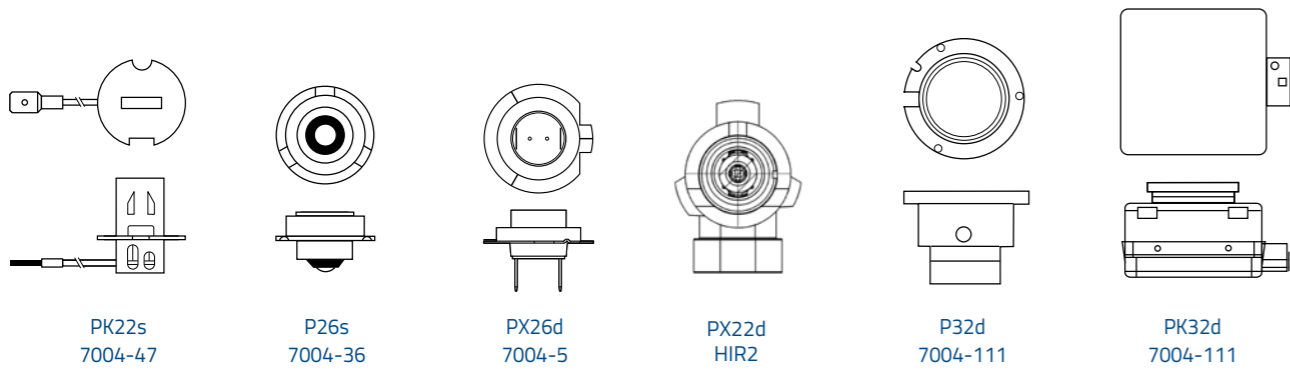
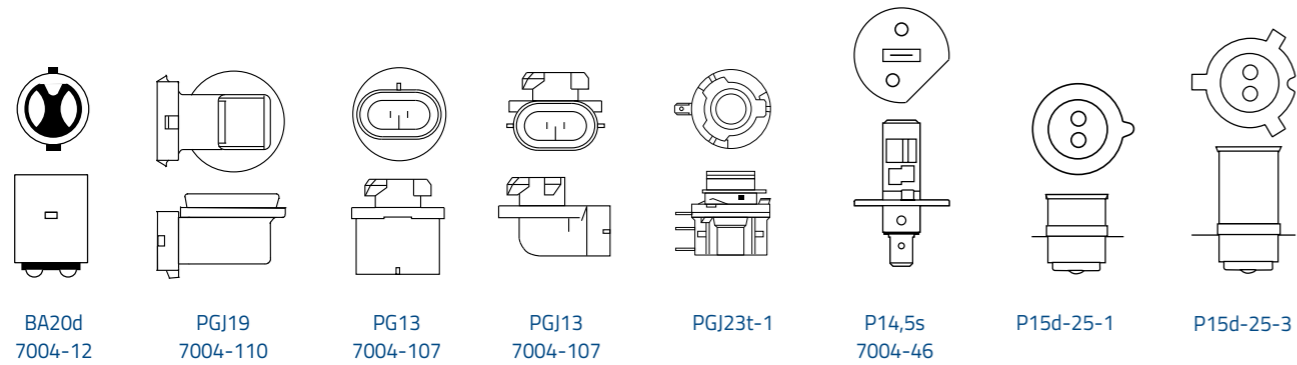
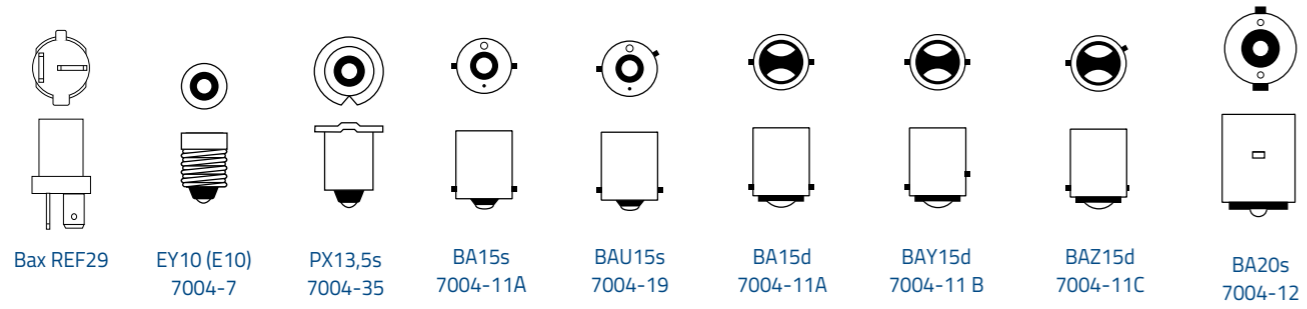
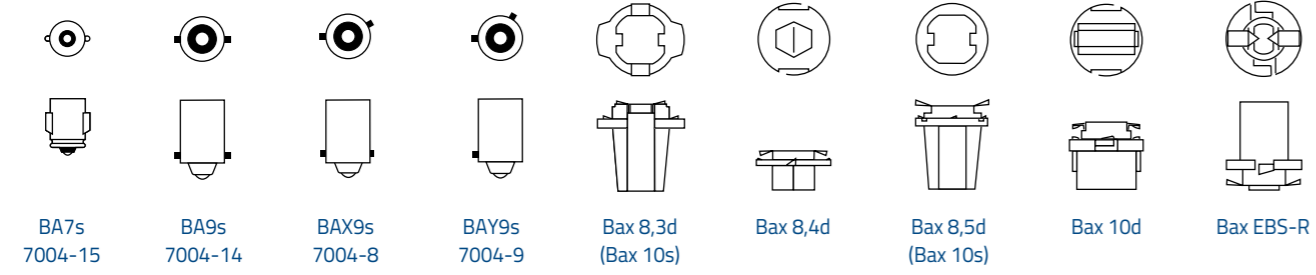





Embalaje comercial



Blísters



Kits de repuestos

## EMBALAJE

### El código de pedido NARVA



Código de tipo de embalaje

Código de pedido

El atractivo diseño del envase proporciona una clara visión del producto en su interior y su estructura resistente protege el contenido durante el envío y también durante la exposición en la tienda.

- / Económico
- / Menos residuos
- / Información clara
- / Estructura resistente

### Embalaje especial NARVA

Nuestro embalaje puede utilizarse para paquetes dobles especiales o para kits de repuesto. La información sobre el producto se presenta de forma sencilla y clara en la parte posterior para ayudar al consumidor a tomar una decisión informada.



C1/CP  
Embalaje comercial

**3000**



S2/SM  
Set de dos / Set de dos especial

**2100**



B1/B2  
Blíster individual / Blíster doble

**4000**



Pack especial doble para LED

**3000**

### Abreviaturas para nombres de gamas

- HD** Heavy Duty  
Resiste todas las vibraciones
- LL** Long Life  
Doble vida útil
- RA** Rallye\*  
Excelente luminosidad
- RP50+** Range Power 50+  
Hasta un 50% más visibilidad
- RP150** Range Power 150  
Hasta un 150% más luminosidad

- RPB+** Range Power Blue+  
Hasta un 50% más visibilidad,  
elegante blanco
- RPW** Range Power White\*  
4500 K de xenón blanco
- RPLED** Range Performance LED\*\*  
Hasta 6500K, luz blanca intensa

\*Importante En Europa se prohíbe la venta de productos que no lleven el logotipo de certificación ECE y no estén homologados.



\*\*Es su propia responsabilidad usar las Luces LED retrofit conforme con los requisitos legales aplicables.



# **NARVA**

**D A S L I C H T**

**Lumileds Germany GmbH**

Philipsstraße 8  
52068 Aachen  
Germany

Tel. +49 (0)3741 746 8181  
E-mail: [info@narva-light.com](mailto:info@narva-light.com)  
[www.narva-light.com](http://www.narva-light.com)

© 2022 Lumileds Holding B.V.  
ES-ES • 2022

Member of **NARVA e.V. Germany** ///