

**NARVA**  
DAS LICHT



## **AUTOMOTIVE LIGHTING**

---

Catalog 2022

# TABLE OF CONTENTS

## NARVA LIGHT EXPERT

04

### LED

#### 12/24V CAR & TRUCK



**WHICH LAMP TYPE DO YOU NEED ?** 10

**SIGNALING  
AND INTERIOR LAMPS**

**HEADLAMPS**  
Range Performance LED 12

Range Performance LED 13

### HALOGEN

#### 12V CAR



**WHICH LAMP TYPE DO YOU NEED ?** 18

**SIGNALING  
AND INTERIOR LAMPS**

**HEADLAMPS**  
Standard 21  
Long Life 23  
Range Power 50+ 24  
Range Power 150 24  
Range Power Blue+ 25  
Range Power White 26  
Rallye 27  
American Types 28

Standard 30  
Miniature lamps 32  
Wedge base lamps 32  
Festoons 33  
Plastic base lamps (Bax) 34  
Range Power Blue+ 36

**SPARE KITS** 38

**SALES TOOLS** 39

#### 24V TRUCK



**WHICH LAMP TYPE DO YOU NEED ?** 41

**HEADLAMPS**  
Standard 42  
Heavy Duty 43  
Rallye 43

Miniature lamps 45  
Wedge base lamps 46  
Festoons 46  
Plastic base lamps (Bax) 47  
Heavy Duty 48

**SPARE KITS** 49

**SIGNALING  
AND INTERIOR LAMPS**  
Standard 44

**SALES TOOLS** 49

#### 12V TWO-WHEELER



**WHICH LAMP TYPE DO YOU NEED ?** 51

**HEADLAMPS**  
Standard 52

### XENON

#### CAR & TRUCK



**WHICH LAMP TYPE DO YOU NEED ?** 57

**HEADLAMPS**  
Standard 59

**TECHNICAL ILLUSTRATIONS** 60  
**BASES (IEC 60061-1)** 62  
**PACKAGING** 64



For more information about NARVA, please visit our website at  
[WWW.NARVA-LIGHT.COM](http://WWW.NARVA-LIGHT.COM)

# THE AUTOMOTIVE LIGHTING EXPERTS

## OUR CUSTOMERS COME FIRST

**At NARVA, customer satisfaction is our number one priority.** NARVA delivers high-quality automotive lighting products so that professionals can fully satisfy their customers' needs. With NARVA, garages and shops are able to deliver reliable products and quality service at an affordable price. NARVA has developed a comprehensive product portfolio in order to meet the needs of professionals all around the world.

Dedicated NARVA teams and distributors are committed to serving and informing our customers worldwide. We strive to efficiently and effectively meet all customer and market demands in all areas of our business.

Our sales offices, together with a central warehouse, provide attentive customer care and an efficient delivery service.

As today's roads become more congested, we believe it's necessary for all drivers to be able to afford a high-quality and reliable lighting solution for increased safety and visibility.

## QUALITY LIGHTING AT AN AFFORDABLE PRICE, NOW AVAILABLE TO EVERYONE.

## OUR AFFORDABLE QUALITY

- / More than 70 years of automotive lighting experience
- / Comprehensive testing throughout the entire production process
- / Constant quality control of every lamp \*ECE = Economic Commission for Europe
- / Compliance testing and international certification processes, including IATF 16949, DIN EN ISO 14001, ECE R37, ECE R99
- / Ongoing investment in product innovation and new processes.

The quality of NARVA products and production processes are regularly controlled. Our products adhere to ECE\* regulations and other legal requirements.

NARVA production, as well as marketing and logistics processes, are regularly controlled with the help of today's international IATF standards.

The ECE created international guidelines for the automotive industry and its suppliers in order to reduce trade barriers and increase traffic safety. Products that do not conform to ECE regulations cannot be sold in Europe. NARVA products adhere to ECE regulations 37 for filament lamps and 99 for gas discharge lamps that provide guidelines including measurements, luminous flux and power. The IATF 16949 is our proof of strong integration of safety and stability in our production, marketing and logistics.

\*ECE = Economic Commission for Europe



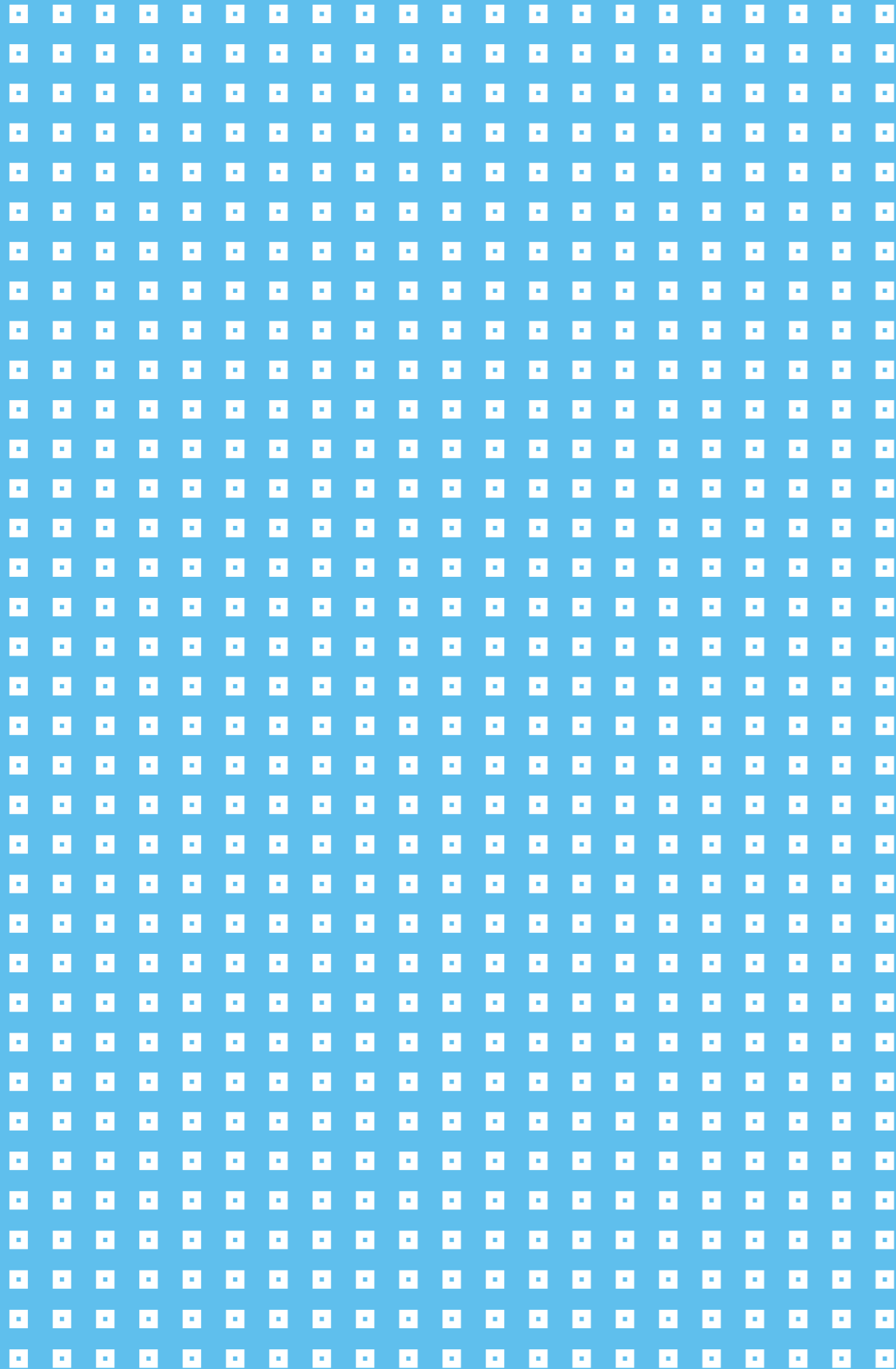

# LED SOLUTIONS

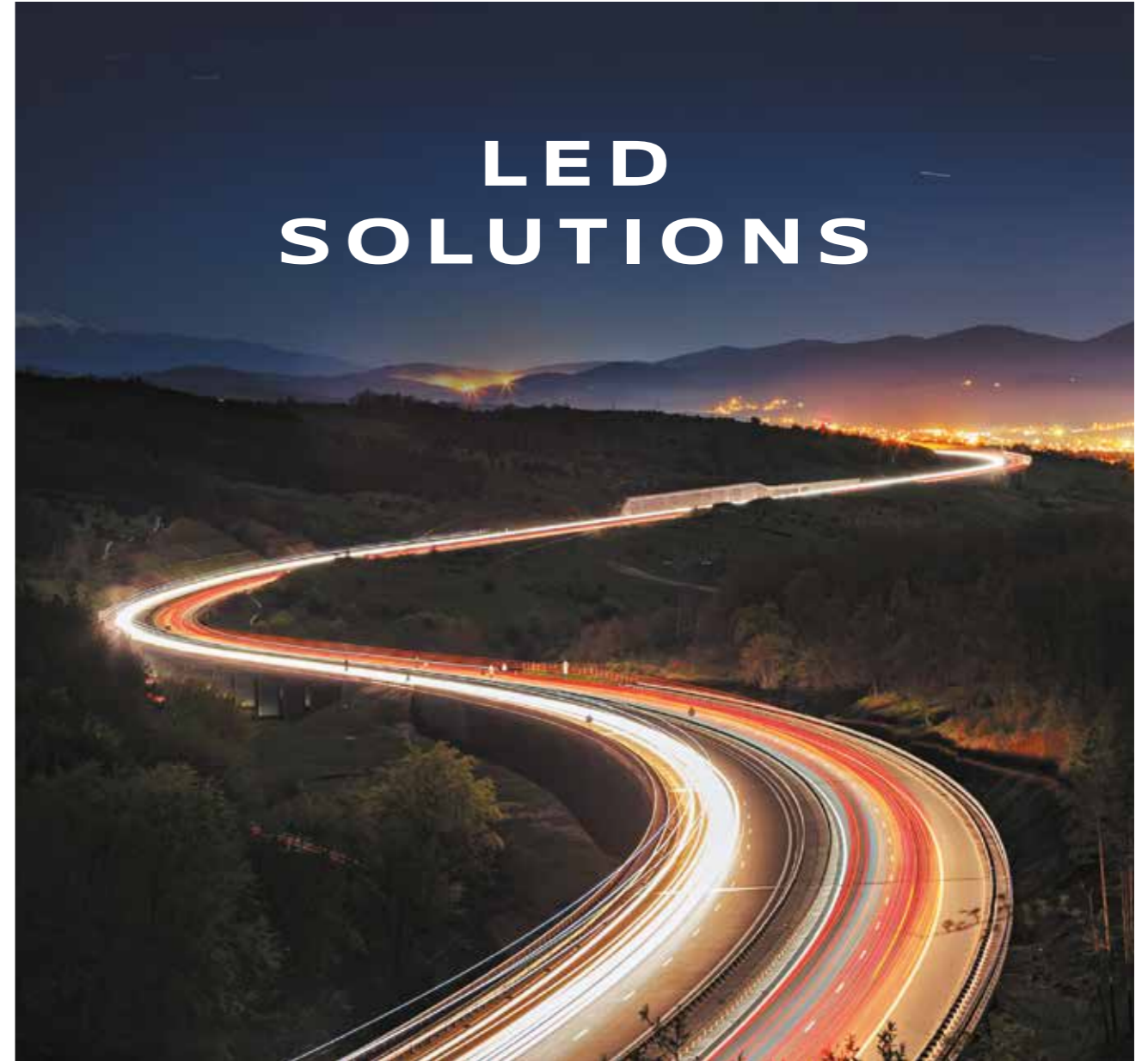

## RANGE PERFORMANCE LED



- HL [≈H1]
- HL [≈H3]
- HL [≈H4]
- HL [≈H7]
- HL [≈H11]
- FL [≈H8/H11/H16]
- HL [≈HB3/HB4]
- HL [≈HIR2]

It is your own responsibility to ensure that the use of the LED retrofit lights complies with applicable local legal requirements.



# LED

## 12/24V LAMPS



Transform your car from standard to stylish in one easy move with the gorgeous **NARVA Range Performance LED** bulbs.

With crisp, white LED light and brilliant colors, not only will you look good, but also see more and react faster.

## RANGE PERFORMANCE

Illuminate the road with bright white headlights, ensuring great visibility and an amazing appearance. Due to their compact size and “twist and fit” design, these bulbs are one of the easiest to install.

With superior thermal resistance, the lights are protected from heat damage, making them extra durable and long-lasting. Advanced optical design ensures safe driving without glaring oncoming road users.



Standard halogen



Range Performance LED

## INSTALLING HEADLIGHT BULBS

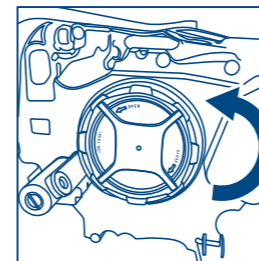

1 Remove the cover of the headlamp.

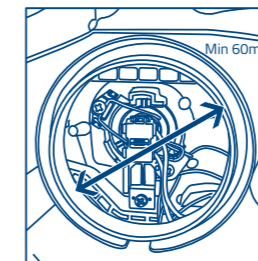

2 Make sure the inside diameter is at least 60 mm.

### For H1, H3, H4 and H7 types

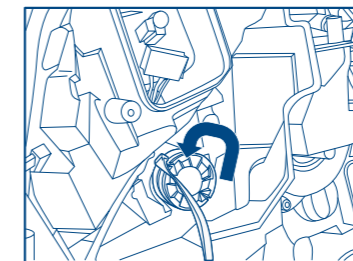
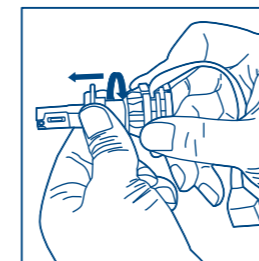

3 Take out the center ring and install it into the holder. Secure the ring with the metallic clip. Install the bulb into the holder. Gently twist the bulb to secure it.

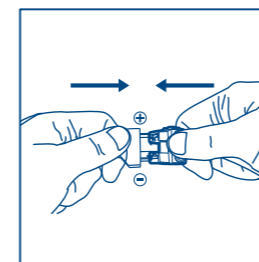

4 Connect the bulb to the car connector (respecting polarity for H1 and H3 types).

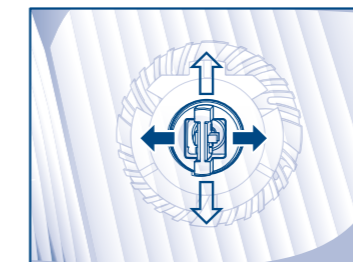

5 Make sure the burner is vertically positioned.

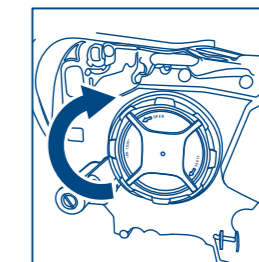

6 Seal the cover of the headlamp.

# WHICH TYPE OF LED UPGRADE DO YOU NEED?



## INTERIOR LIGHTS GLOVE COMPARTMENT LIGHTS

## DASHBOARD LIGHTS

## 3<sup>RD</sup> STOP LIGHTS

## TRUNK LIGHTS

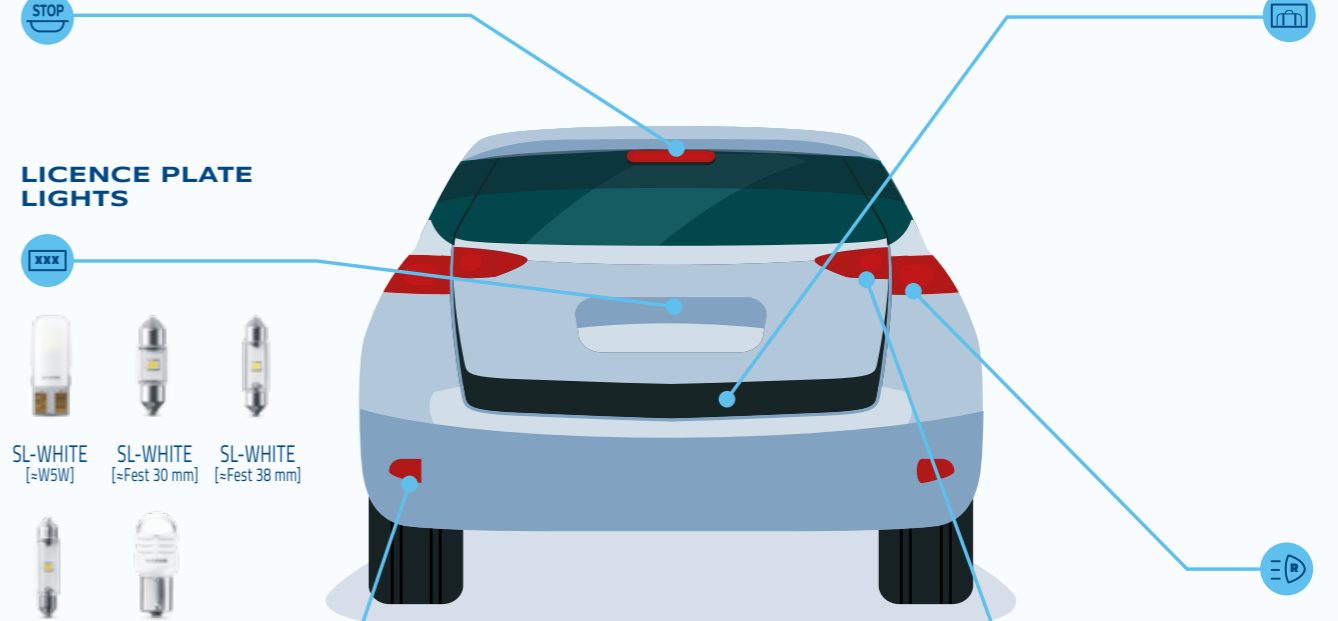
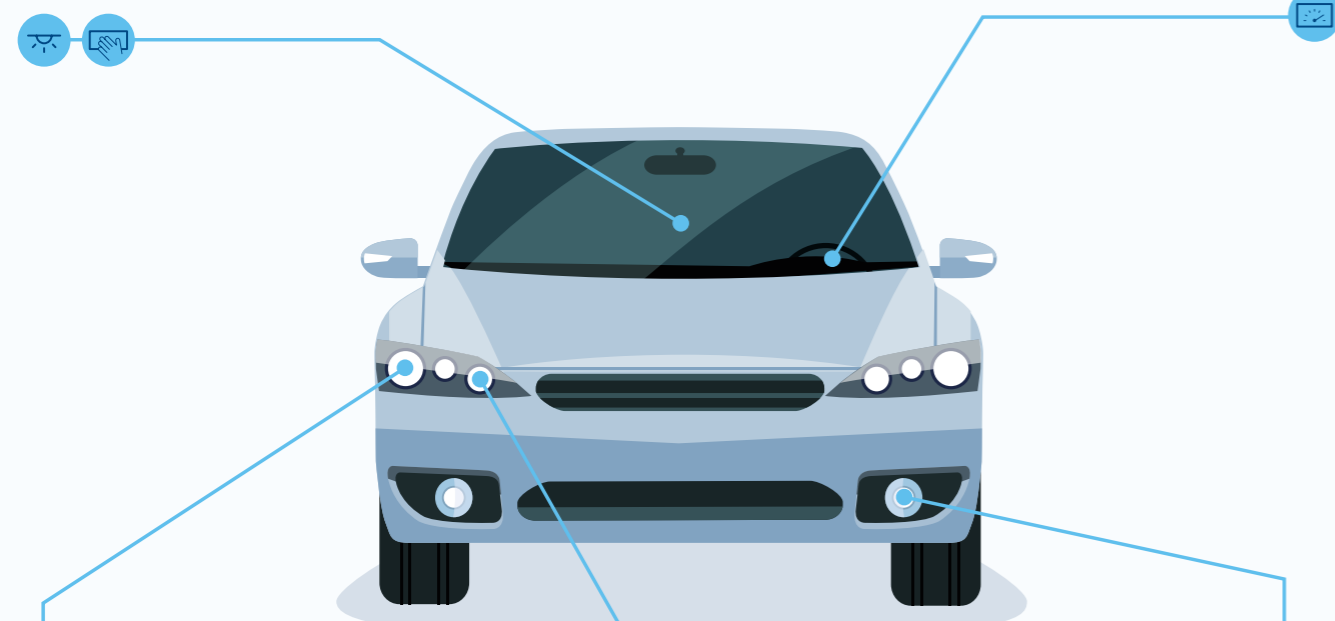

## LOW BEAM HIGH BEAM

## FRONT FOG LIGHTS

## LICENCE PLATE LIGHTS

## REVERSING LIGHTS

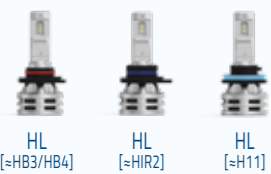
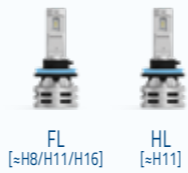









## REAR FOG LIGHTS



## STOP LIGHTS REAR PARKING LIGHTS

It is your own responsibility to ensure that the use of the LED retrofit lights complies with applicable local legal requirements.

## HEADLAMPS

## RANGE PERFORMANCE

Type	Ref. No	V	W	Base	Pieces / PU	Packaging
 HL [≈H1]	0180573000	12/24	19	P14,5s	6	X2
 HL [≈H3]	0180583000	12/24	19	PK22s	6	X2
 HL [≈H4]	0180323000	12/24	24	P43t-38	6	X2
 HL [≈H7]	0180333000	12/24	24	PX26d	6	X2
 HL [≈H11]	0180483000	12/24	24	PGJ19-2	6	X2
 FL [≈H8/H11/H16]	0180363000	12/24	24	PGJ19-1	6	X2
 HL [≈HB3/HB4]	0180383000	12/24	24	P20d/P22d	6	X2
 HL [≈HIR2]	0180443000	12/24	24	PX22d	6	X2

  It is your own responsibility to ensure that the use of the LED retrofit lights complies with applicable local legal requirements.

## SIGNALING AND INTERIOR LAMPS

## RANGE PERFORMANCE

Type	Ref. No	V	W	Base	Pieces / PU	Packaging
 SL-WHITE [≈W5W]	0180744000	12	0.60	W2,1x9,5d	10	B2
 SL-WHITE [≈Fest 30 mm]	0180754000	12	0.60	SV8,5-8	10	B1
 SL-WHITE [≈Fest 38 mm]	0180794000	12	0.60	SV8,5-8	10	B1
 SL-WHITE [≈Fest 43 mm]	0180804000	12	0.60	SV8,5-8	10	B1
 SL-WHITE [≈P21W]	0180894000	12	1.75	BA15s	10	B2
 SL-RED [≈P21W]	0180934000	12	1.75	BA15s	10	B2
 SL-RED [≈P21/5W]	0180964000	12	0.80/1.75	BAY15d	10	B2
 SL-WHITE [≈W21W]	180134000	12	16	PGJ19-1/2/3	6	B2
 SL-RED [≈W21W]	180144000	12	16	P20d/P22d	6	B2
 SL-RED [≈W21/5W]	180154000	12	16	PX22D	6	B2

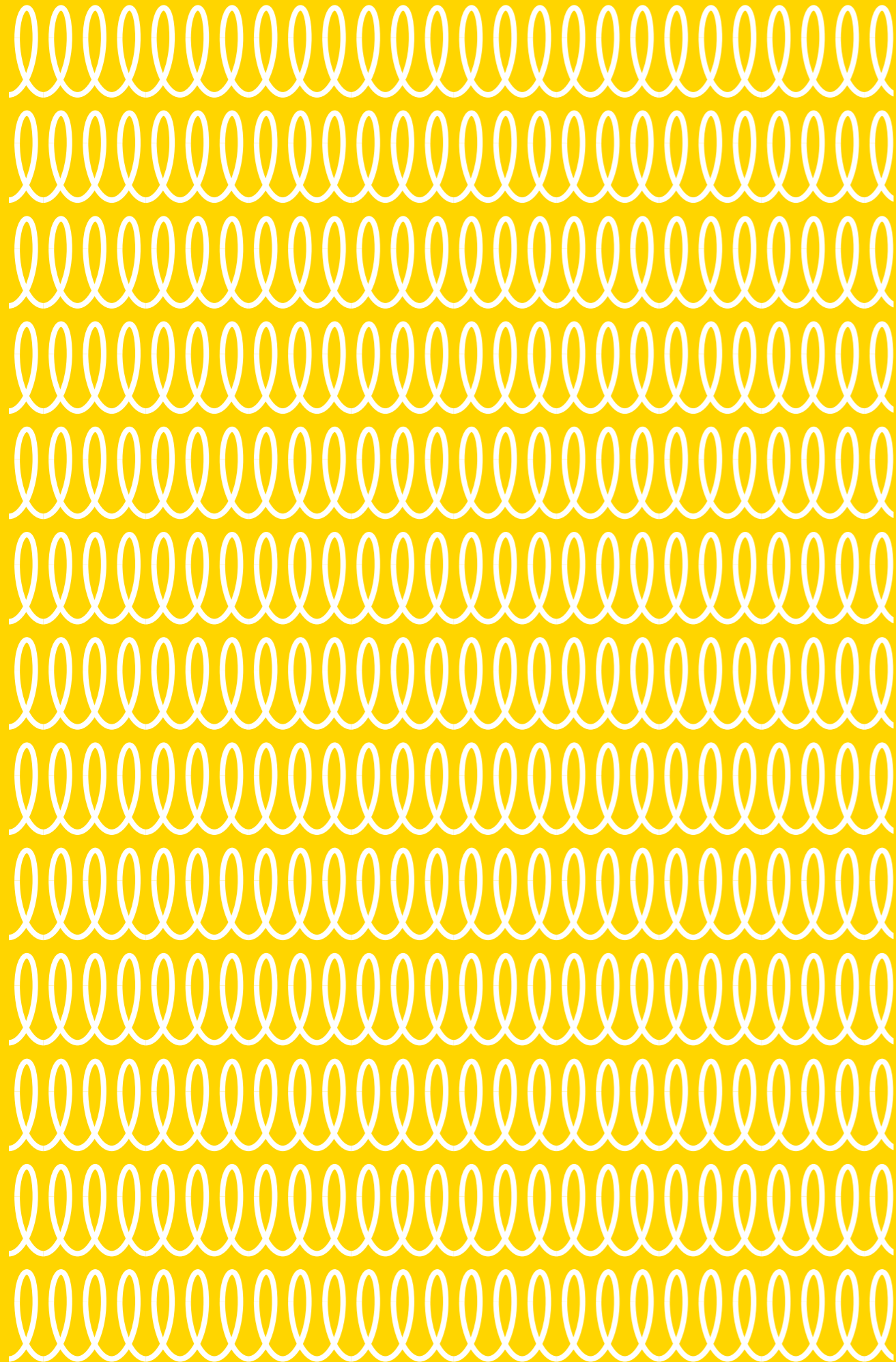



# HALOGEN SOLUTIONS

## CAR

REPLACEMENT	DURABILITY	BETTER VISION		STYLING		
<b>Standard</b> <hr/> Value for money <hr/> 	<b>Long Life</b> <hr/> Double lifetime <hr/> 	<b>Range Power 50+</b> <hr/> Up to 50% more vision <hr/> 	<b>Range Power 150</b> <hr/> Up to 150% more vision <hr/> 	<b>Range Power Blue+</b> <hr/> Up to 50% more vision Stylish white <hr/> 	<b>Range Power White</b> <hr/> 4500 K Xenon White <hr/> 	<b>Rallye</b> <hr/> Extreme brightness <hr/> 
					Non homologué ECE*	Non homologué ECE*

## TRUCK

REPLACEMENT	DURABILITY	STYLING
<b>Standard</b> <hr/> Value for money <hr/> 	<b>Heavy Duty</b> <hr/> Resists all vibrations <hr/> 	<b>Rallye</b> <hr/> Extreme brightness <hr/> 
		Non homologué ECE*

\*Important Products that do not carry the ECE certification logo are not homologated and cannot be sold in Europe.



# HALOGEN SOLUTIONS



## REPLACEMENT

### STANDARD

Our Standard range represents the best value, combining reliability with economy. For drivers seeking the greatest price/performance ratio without sacrificing safety, NARVA Standard is the right choice.



## DURABILITY

### LONG LIFE

Our green range has been especially engineered for long lifetime. Lasting twice as long as standard lamps, these long-lasting lamps will not have to be replaced as often which results in less maintenance combined with a minimal impact on the environment.



## BETTER VISION

### RANGE POWER 50+



### RANGE POWER 50+

Offering up to 50% more vision than a standard lamp, our Range Power 50+ delivers a longer light beam for even greater brightness. It's engineered for drivers to see farther and more clearly for greater safety.



### RANGE POWER 150



### RANGE POWER 150

The new Range Power 150 delivers up to 150% more brightness. The powerful light beam allows drivers to see farther. A special burner design creates a higher lumen output for increased safety and greater performance.



## STYLING

### RANGE POWER BLUE+

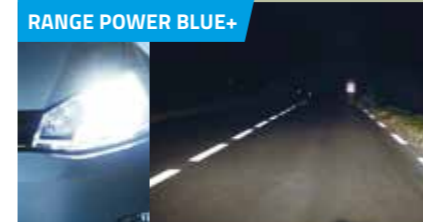

### RANGE POWER BLUE+

Offering up to 50% more vision and up to 30% stylish, cooler light, our Range Power Blue+ is engineered for drivers to see farther and more clearly for greater visibility and safety.



### RANGE POWER WHITE



### RANGE POWER WHITE\*

Our Range Power White offers a bright and stylish white light. The stylish xenon effect obtained by the 4500 K color temperature offers your car an eye-catching look close to daylight.



### RALLYE

### RALLYE\*

Offering high power for more visibility, the Rallye range is engineered for drivers to see farther and more clearly.

\*Non-ECE-homologated. Cannot be sold or used in Europe.



HALOGEN

# WHICH 12V CAR LAMP TYPE DO YOU NEED?



**GLOVE COMPARTMENT LIGHTS**



**INTERIOR LIGHTS**



**DASHBOARD LIGHTS**

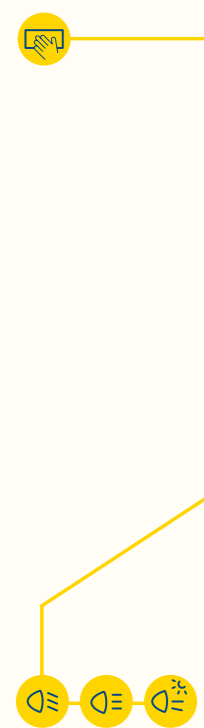

**LOW BEAM  
HIGH BEAM  
DAYTIME RUNNING LIGHTS**



**FRONT INDICATORS**



**FRONT PARKING LIGHTS**



**SIDE INDICATORS**



**FRONT FOG LIGHTS**



**3<sup>RD</sup> STOP LIGHTS**



**LICENCE PLATE LIGHTS**



**TRUNK LIGHTS**



**REAR FOG LIGHTS**



**REAR INDICATORS**

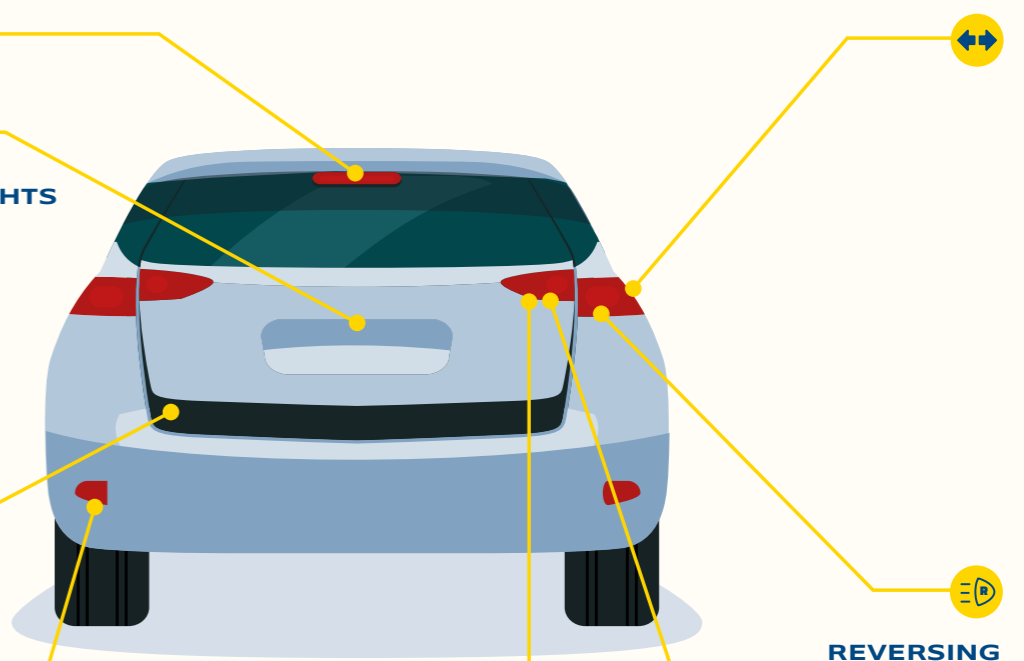

**REVERSING LIGHTS**



**REAR PARKING LIGHTS**



**STOP LIGHTS**



# CAR

## 12V LAMPS













**NARVA** is renowned for manufacturing quality halogen lighting solutions that are durable and reliable.

Our halogen bulbs provide greater visibility and greater safety in all driving conditions.

### HEADLAMPS

STANDARD

	ECE	Ref. No	V	W	Base	Pieces / PU	Packaging
	H1	483203000	12	55	P14,5s	100	C1
		483204000	12	55	P14,5s	10	B1
	H2	484203000	12	55	X511	100	C1
	H3	483213000	12	55	PK22s	100	C1
		483214000	12	55	PK22s	10	B1
	H4	488813000	12	60/55	P43t	100	C1
		488814000	12	60/55	P43t-38	10	B1
	H7	483283000	12	55	PX26d	100	C1
		483284000	12	55	PX26d	10	B1
	H8	480763000	12	55	PGJ19-1	100	C1
	H9	480773000	12	65	PGJ19-5	100	C1
	H10 (9145)	480953000	12	42	PY20d	100	C1
	H11	0480723000	12	55	PGJ19-2	100	C1
	H13 (9008)	480923000	12	60/55	P26,4t	100	C1



12V | CAR |

HALOGEN

## HEADLAMPS

## STANDARD

	ECE	Ref. No	V	W	Base	Pieces / PU	Packaging
	H15	480703000	12	15/55	PGJ23t-1	100	C1
	HIR2	480673000	12	55	PX22d	100	C1
	R2 Halogen	481213000	12	45/40	P45t-41	100	C1
	R2	492113000	12	45/40	P45t	100	C1
	H27W/1	480413000	12	27	PG13	100	C1
	H27W/2	480423000	12	27	PG13	100	C1
	S2	495313000	12	35/35	BA20d	200	C1
	HB1	480043000	12	65/45	P29t	100	CP
	HB2	488823000	12	67/60	P43t-38	100	C1
	HB3	480053000 480054000	12 12	60 60	P20d P20d	100 10	C1 B1

	ECE	Ref. No	V	W	Base	Pieces / PU	Packaging
	HB4	480063000 480064000	12 12	51 51	P22d P22d	100 10	C1 B1

	ECE	Ref. No	V	W	Base	Pieces / PU	Packaging
	HB5	480073000	12	65/55	PX29t	100	C1

## HEADLAMPS

## LONG LIFE

	ECE	Ref. No	V	W	Base	Pieces / PU	Packaging
	H1 LL	483223000	12	55	P14,5s	100	C1

	ECE	Ref. No	V	W	Base	Pieces / PU	Packaging
	H4 LL	488893000	12	60/55	P43t-38	100	C1

	ECE	Ref. No	V	W	Base	Pieces / PU	Packaging
	H7 LL	483293000	12	55	PX26d	100	C1





	ECE	Ref. No	V	W	Base	Pieces / PU	Packaging
	H11 LL	480783000	12	55	PGJ19-2	100	C1

	ECE	Ref. No	V	W	Base	Pieces / PU	Packaging
	862 LL	480595000	12	37.5	PGJ13	300	CP







## HEADLAMPS

### RANGE POWER 50+

	ECE	Ref. No	V	W	Base	Pieces / PU	Packaging
	H1	483343000	12	55	P14,5s	100	C1
	RP50+	483344000	12	55	P14,5s	10	B1
		483342100	12	55	P14,5s	10	S2
	ECE	Ref. No	V	W	Base	Pieces / PU	Packaging
	H3	483353000	12	55	PK22s	100	C1
	RP50+						
	ECE	Ref. No	V	W	Base	Pieces / PU	Packaging
	H4	488613000	12	60/55	P43t-38	100	C1
	RP50+	488614000	12	60/55	P43t-38	10	B1
		488612100	12	60/55	P43t-38	10	S2
	ECE	Ref. No	V	W	Base	Pieces / PU	Packaging
	H7	483393000	12	55	PX26d	100	C1
	RP50+	483394000	12	55	PX26d	10	B1
		483392100	12	55	PX26d	10	S2

## HEADLAMPS

### RANGE POWER 150

	ECE	Ref. No	V	W	Base	Pieces / PU	Packaging
	H1	480682100	12	55	P14,5s	10	S2
	RP150						
	ECE	Ref. No	V	W	Base	Pieces / PU	Packaging
	H4	480692100	12	60/55	P43t-38	10	S2
	RP150						
	ECE	Ref. No	V	W	Base	Pieces / PU	Packaging
	H7	480712100	12	55	PX26d	10	S2
	RP150						
	ECE	Ref. No	V	W	Base	Pieces / PU	Packaging
	H11	481012100	12	55	PGJ19-2	10	S2
	RP150						

## HEADLAMPS

### RANGE POWER BLUE+

	ECE	Ref. No	V	W	Base	Pieces / PU	Packaging
	H1	486303000	12	55	P14,5s	100	C1
	RPB+	486304000	12	55	P14,5s	10	B1
		486302100	12	55	P14,5s	10	S2
	ECE	Ref. No	V	W	Base	Pieces / PU	Packaging
	H3	486333000	12	55	PK22s	100	C1
	RPB+						
	ECE	Ref. No	V	W	Base	Pieces / PU	Packaging
	H4	486773000	12	60/55	P43t-38	100	C1
	RPB+	486774000	12	60/55	P43t-38	10	B1
		486772100	12	60/55	P43t-38	10	S2
	ECE	Ref. No	V	W	Base	Pieces / PU	Packaging
	H7	486383000	12	55	PX26d	100	C1
	RPB+	486384000	12	55	PX26d	10	B1
		486382100	12	55	PX26d	10	S2
	ECE	Ref. No	V	W	Base	Pieces / PU	Packaging
	HB2	486763000	12	67/60	P43t-38	100	C1
	RPB+						
	ECE	Ref. No	V	W	Base	Pieces / PU	Packaging
	HB3	486163000	12	60	P20d	100	C1
	RPB+						
	ECE	Ref. No	V	W	Base	Pieces / PU	Packaging
	HB4	486133000	12	51	P22d	100	C1
	RPB+						
	ECE	Ref. No	V	W	Base	Pieces / PU	Packaging
	HB5	486293000	12	65/55	PX29t	100	C1
	RPB+						



12V | CAR |

HALOGEN



HEADLAMPS









RANGE POWER WHITE\*

Type	Ref. No	V	W	Base	Pieces / PU	Packaging
 H1 RPW	486412100	12	55	P14,5s	10	S2
 H3 RPW	486022100	12	55	PK22s	10	S2
 H4 RPW	486802100	12	60/55	P43t-38	10	S2
 H7 RPW	486072100	12	55	PX26d	10	S2
 HB3 (9005) RPW	486252100	12	65	P20d	10	S2
 HB4 (9006) RPW	486262100	12	55	P22d	10	S2
 H1/W5W PW kit	980142100	H1 W5W	85 5	P14,5s W2,1x9,5d	2 2	SM
 H4/W5W PW kit	980152100	H4 W5W	100/90 5	P43t W2,1x9,5d	2 2	SM
 H7/W5W PW kit	980162100	H7 W5W	85 5	PX26d W2,1x9,5d	2 2	SM

\*Important Products that do not carry the ECE certification logo are not homologated and cannot be sold in Europe.

HEADLAMPS

RALLYE\*

Type	Ref. No	V	W	Base	Pieces / PU	Packaging
 H1 Rallye	483503000 483803000	12	100 130	P14,5s P14,5s	100 100	C1 C1
 H3 Rallye	483513000 483813000	12	100 130	PK22s PK22s	100 100	C1 C1
 H4 Rallye P43t	489013000 489014000 489113000 489513000	12	100/90 100/90 100/55 130/100	P43t-38 P43t-38 PX26d P43t	100 10 100 100	C1 B1 C1 C1
 H4 Rallye P45t	488843000 489043000	12	60/55 100/90	P45t P45t-41	100 100	C1 C1
 H7 Rallye	483583000	12	80	PX26d	100	C1
 HB1 Rallye	480343000	12	100/80	P29t	100	C1
 HB3 Rallye	480253000	12	100	P20d	100	C1
 HB4 Rallye	480263000	12	70	P22d	100	C1
 HB5 Rallye	480313000	12	100/80	PX29t	100	C1

\*Important Products that do not carry the ECE certification logo are not homologated and cannot be sold in Europe.













12V | CAR |







HALOGEN



# HEADLAMPS

## AMERICAN TYPES

US Type	Ref. No	V	W	Base	Pieces / PU	Packaging
 9004 (HB1)	480043000	12	65/45	P29t	100	CP
 9003 (HB2)	488823000	12	67/60	P43t-38	100	C1
 9005 (HB3)	480053000 480054000	12 12	60 60	P20d P20d	100 10	C1 B1
 9006 (HB1)	480063000 480064000	12 12	51 51	P22d P22d	100 10	C1 B1
 9007 (HB5)	480073000	12	65/45	PX29t	100	C1
 9008 (H13)	480923000	12	60/55	P26,4t	100	C1
 9145 (H10)	480953000	12	42	Y20d	100	C1
 880	480393000	12.8	27	PG13	100	C1
 881	480403000	12.8	27	PGJ13	100	C1
 885	480553000	12.8	50	PG13	100	C1

US Type	Ref. No	V	W	Base	Pieces / PU	Packaging
 886	480563000	12.8	50	PGJ13	100	C1
 889	480453000	12.8	27	PGJ13	100	C1
 890	480463000	12.8	27	PG13	100	C1
 893	480513000	12.8	37.5	PG13	100	C1
 894	480543000	12.8	37.5	PGJ13	100	C1
 896	480523000	12.8	37.5	PGJ13	100	C1





12V | CAR |





HALOGEN





	ECE	Ref. No	V	W	Base	Pieces / PU	Packaging
	P21/4W	178813000	12	21/4	BAZ15d	200	CP
		178814000	12	21/4	PX26d	10	B2

	ECE	Ref. No	V	W	Base	Pieces / PU	Packaging
	P21/5W	179163000	12	21/5	BAY15d	200	CP
		179164000	12	21/5	BAY15d	10	B2

	ECE	Ref. No	V	W	Base	Pieces / PU	Packaging
	(Stop P25) BA15d	179183000	12	21/5	BA15d	200	CP

	ECE	Ref. No	V	W	Base	Pieces / PU	Packaging
	R5W	171713000	12	5	BA15s	200	CP
	BA15s	171714000	12	5	BA15s	10	B2

	ECE	Ref. No	V	W	Base	Pieces / PU	Packaging
	R5W	171723000	12	5	BA15d	200	CP
	BA15d						

	ECE	Ref. No	V	W	Base	Pieces / PU	Packaging
	R10W	173113000	12	10	BA15s	200	CP
		173114000	12	10	BA15s	10	B2

	ECE	Ref. No	V	W	Base	Pieces / PU	Packaging
	RY10W	173173000	12	10	BAU15s	200	CP

	ECE	Ref. No	V	W	Base	Pieces / PU	Packaging
		170513000	12	2	BA7s	200	CP

	ECE	Ref. No	V	W	Base	Pieces / PU	Packaging
		170533000	12	2	BA9s	200	CP

	ECE	Ref. No	V	W	Base	Pieces / PU	Packaging
	T4W	171313000	12	4	BA9s	200	CP

SIGNALING AND INTERIOR LAMPS

STANDARD

	ECE	Ref. No	V	W	Base	Pieces / PU	Packaging
	(Stop P22)	174113000	12	15	BA15s	200	CP

	ECE	Ref. No	V	W	Base	Pieces / PU	Packaging
	(Stop P25) BA15s	175113000	12	18	BA15s	200	CP

	ECE	Ref. No	V	W	Base	Pieces / PU	Packaging
	P21W	176353000	12	21	BA15s	200	CP
		176354000	12	21	BA15s	10	B2
		176403000	12	21	BAU15s	200	CP

	ECE	Ref. No	V	W	Base	Pieces / PU	Packaging
	PY21W Amber	176383000	12	21	BAU15s	200	CP
		176384000	12	21	BAU15s	10	B2



12V | CAR |

HALOGEN



SIGNALING AND INTERIOR LAMPS

MINIATURE LAMPS

ECE	Ref. No	V	W	Base	Pieces / PU	Packaging
(H5W)	178303000	12	5	BA9s	200	CP
H6W	681613000	12	6	BAX9s	200	CP
(H10W)	178333000	12	10	BA9s	200	CP
(H20W)	178353000	12	20	BA9s	200	CP
H21W	681913000	12	21	BAY9s	200	CP

SIGNALING AND INTERIOR LAMPS

WEDGE BASE LAMPS

ECE	Ref. No	V	W	Base	Pieces / PU	Packaging
(W1,2W) Frosted	170323000	12	1.2	W2x4,6d	200	CP
(W1,2W)	170373000	12	1.2	W2x4,6d	200	CP
(W2,2W)	170593000	12	2.2	W2,1x9,5d	200	CP
W2,3W	170733000	12	2.3	W2x4,6d	200	CP

ECE	Ref. No	V	W	Base	Pieces / PU	Packaging
W3W	170973000	12	3	W2,1x9,5d	200	CP
W5W	171773000 171774000	12 12	5 5	W2,1x9,5d W2,1x9,5d	200 10	CP B2
WY5W	171693000	12	5	W2,1x9,5d	200	CP
W16W	176313000	12	16	W2,1x9,5d	200	CP
W21W	176323000	12	21	W3x16d	200	CP
WY21W	176293000	12	21	WX3x16d	200	CP
W21/5W	179193000	12	21/5	W3x16q	200	CP

ECE	Ref. No	V	W	Base	Pieces / PU	Packaging
T8.2x30	170943000	12	3	SV7,5	200	CP
C5W	171253000 171254000	12 12	5 5	SV8,5 SV8,5	200 10	CP B2

SIGNALING AND INTERIOR LAMPS

FESTOON LAMPS





12V | CAR |

HALOGEN





	ECE	Ref. No	V	W	Base	Pieces / PU	Packaging
	T10.5x43	171753000	12	5	SV8,5	200	CP

	ECE	Ref. No	V	W	Base	Pieces / PU	Packaging
	T10.5x43	173143000	12	10	SV8,5	200	CP

	ECE	Ref. No	V	W	Base	Pieces / PU	Packaging
	T10.5x30	173153000	12	10	SV8,5	200	CP

	ECE	Ref. No	V	W	Base	Pieces / PU	Packaging
	T10.5x38	173163000	12	10	SV8,5	200	CP

	ECE	Ref. No	V	W	Base	Pieces / PU	Packaging
	T15x43	175123000	12	18	SV8,5	200	CP

	ECE	Ref. No	V	W	Base	Pieces / PU	Packaging
	C21W	176343000	12	21	SV8,5	200	CP

## SIGNALING AND INTERIOR LAMPS

## PLASTIC BASE LAMPS (BAX)

	ECE	Ref. No	V	W	Base	Pieces / PU	Packaging
		170063000	12	0.4	Bax 8,5d blue violet	200	CP

	ECE	Ref. No	V	W	Base	Pieces / PU	Packaging
		170193000	12	1	Bax 8,5d orange	200	CP

	ECE	Ref. No	V	W	Base	Pieces / PU	Packaging
		170273000	12	1.2	Bax 8,4d light blue	200	CP

	ECE	Ref. No	V	W	Base	Pieces / PU	Packaging
		170283000	12	1.2	Bax 8,4d black	200	CP

	ECE	Ref. No	V	W	Base	Pieces / PU	Packaging
		170293000	12	1.2	Bax 8,5d blue	200	CP

	ECE	Ref. No	V	W	Base	Pieces / PU	Packaging
		170353000	12	1.2	Bax 8,5d black	200	CP

	ECE	Ref. No	V	W	Base	Pieces / PU	Packaging
		170363000	12	1.2	Bax 8,3d black	200	CP

	ECE	Ref. No	V	W	Base	Pieces / PU	Packaging
		170463000	12	1.1	Bax 8,4d orange	200	CP

	ECE	Ref. No	V	W	Base	Pieces / PU	Packaging
		170473000	12	1.3	Bax 8,4d olive green	200	CP





	ECE	Ref. No	V	W	Base	Pieces / PU	Packaging
		170483000	12	1.5	Bax 8,4d beige	200	CP

	ECE	Ref. No	V	W	Base	Pieces / PU	Packaging
		170493000	12	1.5	Bax 8,5d beige	200	CP

	ECE	Ref. No	V	W	Base	Pieces / PU	Packaging
		170503000	12	1.5	Bax 8,5d yellow	200	CP



	ECE	Ref. No	V	W	Base	Pieces / PU	Packaging
		170523000	12	2	Bax 8,5d light green	200	CP



	ECE	Ref. No	V	W	Base	Pieces / PU	Packaging
		170543000	12	2	Bax 8,4d light green	200	CP
		170573000	12	2	Bax 8,5d green	200	CP
		170583000	12	2	Bax 8,3d blue	200	CP
		170603000	12	1.8	Bax 8,4d beige	200	CP
		171633000	12	5	Bax 10d black	100	C1



## SIGNALING AND INTERIOR LAMPS

### RANGE POWER BLUE+

	ECE	Ref. No	V	W	Base	Pieces / PU	Packaging
	W5W RPB+	171893000	12	5	W2,1x9,5d	200	CP
	H6W RPB+	681633000	12	6	BAX9s	200	CP

## SIGNALING AND INTERIOR LAMPS

### AMERICAN TYPES

	US Type	Ref. No	V	W	Base	Pieces / PU	Packaging
	3156	179413000	12.8	32CP	W2,5x16d	200	CP
	3157	179453000	12.8/14	32/3CP	W2,5x16q	200	CP
	3157 NA	179483000	12.8/14	24/2.2CP	W2,5x16q	200	CP



12V | CAR |

HALOGEN



## SPARE KITS

## STANDARD

In many European countries it's compulsory or recommended to have a spare kit in the vehicle. Our Spare kits provide drivers with the safety they need while on the road or traveling.

	<b>Description</b>	<b>Ref. No</b>	<b>Content</b>	<b>W</b>	<b>Base</b>	<b>N° of pieces</b>		
	<b>Mini spare kit H4</b>	<b>980043010</b>	H4	60/55	P43t	1		
			P21W	21	BA15s	1		
			R5W	5	BA15s	1		
			W5W	5	W2,1x9,5d	1		
			Flat fuse			2		
<b>Packing quantity</b>					<b>20</b>			
	<b>Description</b>	<b>Ref. No</b>	<b>Content</b>	<b>W</b>	<b>Base</b>	<b>N° of pieces</b>		
	<b>Spare kit H4</b>	<b>984003010</b>	H4	60/55	P43t	1		
			P21/5W	21/5	BAY15d	1		
			P21W	21	BA15s	1		
			R5W	5	BA15s	1		
			C5W	5	SV8,5	1		
			W5W	5	W2,1x9,5d	1		
			Flat fuse			4		
			<b>Packing quantity</b>					<b>20</b>
	<b>Description</b>	<b>Ref. No</b>	<b>Content</b>	<b>W</b>	<b>Base</b>	<b>N° of pieces</b>		
	<b>Spare kit H7/H1</b>	<b>984353010</b>	H7	55	PX26d	1		
			17	55	P14,5s	1		
			P21/5W	21/5	BAY15d	1		
			P21W	21	BA15s	1		
			PY21W	21	BAU15s	1		
			C5W	5	SV8,5	1		
			W5W	5	W2,1x9,5d	1		
			Flat fuse			4		
			<b>Packing quantity</b>					<b>20</b>

## SPARE KITS

## RANGE POWER WHITE\*

	<b>Description</b>	<b>Ref. No</b>	<b>Content</b>	<b>W</b>	<b>Base</b>	<b>N° of pieces</b>
	<b>RPW kit H1/W5W</b>	<b>980142100</b>	H1	85	P14,5s	2
			W5W	5	W2,1x9,5d	2
	<b>Packing quantity</b>					<b>10</b>
	<b>Description</b>	<b>Ref. No</b>	<b>Content</b>	<b>W</b>	<b>Base</b>	<b>N° of pieces</b>
	<b>RPW kit H1/W5W</b>	<b>980152100</b>	H4	100/90	P43t	2
			W5W	5	W2,1x9,5d	2
	<b>Packing quantity</b>					<b>10</b>
	<b>Description</b>	<b>Ref. No</b>	<b>Content</b>	<b>W</b>	<b>Base</b>	<b>N° of pieces</b>
	<b>RPW kit H7/W5W</b>	<b>980162100</b>	H7	85	P14,5s	2
			W5W	5	W2,1x9,5d	2
	<b>Packing quantity</b>					<b>10</b>

\*Important Products that do not carry the ECE certification logo are not homologated and cannot be sold in Europe.

## SALES TOOLS

	<b>Counter display</b>		<b>Floor display</b>
	<b>GOC: 98027700</b>		<b>GOC: 99026700</b>
	Delivered with		Durable cardboard floor display, delivered empty.
	<ul style="list-style-type: none"> <li>20x H7 Standard C1</li> <li>10x H4 Standard C1</li> </ul>		<ul style="list-style-type: none"> <li>12 hooks</li> <li>Exchangeable header</li> </ul>
	<b>Wall dispenser 12V</b>	<b>GOC (empty): 980173000</b>	<b>GOC (filled): 980223000</b>
		Delivered empty or filled with lamps (see composition below).	
		Resistant metallic housing	
		Compact size: 37 x 17.6 x 59.5 cm	
		Lockable	
		Delivered with	<ul style="list-style-type: none"> <li>10x H1</li> <li>10x H3</li> <li>30x H4</li> <li>50x H7</li> <li>30x P21/5W</li> </ul>
		<ul style="list-style-type: none"> <li>20x Fest T10,5x43</li> <li>20x W1,2W</li> <li>20x W3W</li> <li>30x W5W</li> </ul>	

# TRUCK

## 24V LAMPS



### WHICH TRUCK 24V LAMP TYPE DO YOU NEED?

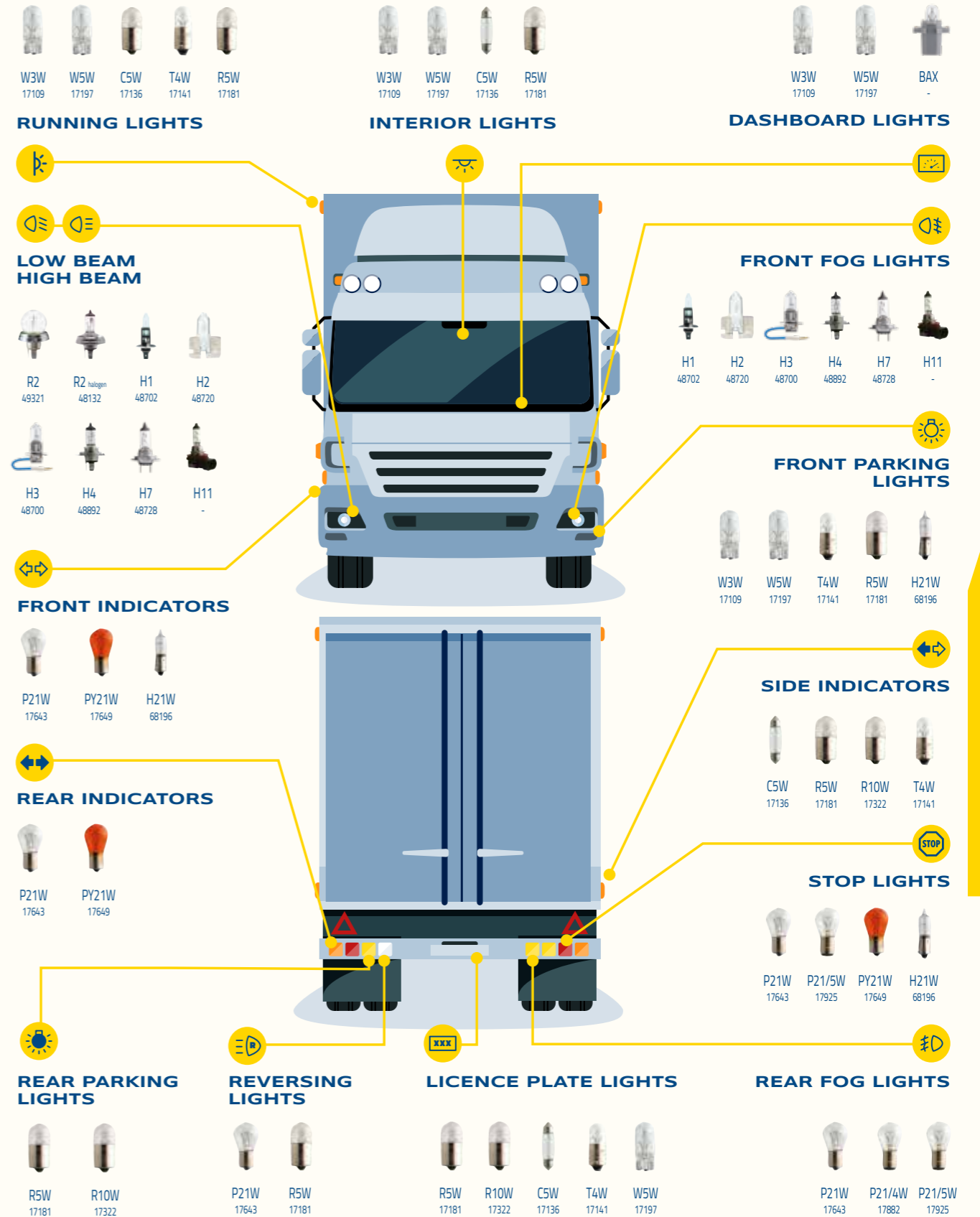

Combining vibration resistance with high quality, our 24V lighting ranges are robust and dependable for today's trucks and other heavy-duty vehicles.

**NARVA** truck headlamps feature vibration resistance and superior quality.

Check out our 24V range when greater strength and durability are required.







## HEADLAMPS

### STANDARD

	ECE	Ref. No	V	W	Base	Pieces / PU	Packaging
	H1	487023000	24	70	P14,5s	100	C1
		487024000	24	70	P14,5s	10	B1
	H2	487203000	24	70	X511	100	C1
	H3	487003000	24	70	PK22s	100	C1
	H4	488923000	24	75/70	P43t	100	C1
		488924000	24	75/70	P43t-38	10	B1
	H7	487283000	24	70	PX26d	100	C1
		487284000	24	70	PX26d	10	B1
	R2 Halogen	481323000	24	55/50	P45t-41	100	C1
	R2	493213000	24	55/50	P45t	100	C1





## HEADLAMPS

### HEAVY DUTY

	ECE	Ref. No	V	W	Base	Pieces / PU	Packaging
	H1 HD	487083000	24	70	P14,5s	100	C1
	H3 HD	487093000	24	70	PK22s	100	C1
	H4 HD	488983000	24	75/70	P43t-38	100	C1
	H7 HD	487293000	24	70	PX26d	100	C1

## HEADLAMPS

### RALLYE\*

	Type	Ref. No	V	W	Base	Pieces / PU	Packaging
	H1 Rallye	483503000	12	100	P14,5s	100	C1
		483803000	12	130	P14,5s	100	C1
	H3 Rallye	483513000	12	100	PK22s	100	C1
		483813000	12	130	PK22s	100	C1
	H4 Rallye	489013000	12	100/90	P43t-38	100	C1
	P43t	489014000	12	100/90	P43t-38	10	B1
		489113000	12	100/55	PX26d	100	C1
		489513000	12	130/100	P43t	100	C1
	H4 Rallye P45t	488843000	12	60/55	P45t	100	C1
		489043000	12	100/90	P45t-41	100	C1

\*Important Products that do not carry the ECE certification logo are not homologated and cannot be sold in Europe.











24V | TRUCK |

HALOGEN

SIGNALING AND INTERIOR LAMPS

STANDARD

	ECE	Ref. No	V	W	Base	Pieces / PU	Packaging
		179273000	24	21/5	BA15d	200	CP
	P21W	176433000 176434000	24	21	BA15s	200 10	CP B2
	P21/4W	178823000	24	21/4	BAZ15d	200	CP
	P21/5W	179253000	24	21/5	BAY15d	200	CP
	Stop P22	174213000	24	15	BA15s	200	CP
	R5W BA15s	171813000 171814000	24	5	BA15s	200 10	CP B2
	R5W	171823000	24	5	BA15d	200	CP
	R10W	173223000	24	10	BA15d	200	CP
		170613000	24	3	BA7s	200	CP
		170633000	24	2	BA9s	200	CP



ECE	Ref. No	V	W	Base	Pieces / PU	Packaging
T4W	171413000	24	4	BA9s	200	CP

SIGNALING AND INTERIOR LAMPS

MINIATURE LAMPS



ECE	Ref. No	V	W	Base	Pieces / PU	Packaging
H21W	681963000	24	21	BAY9s	200	CP





24V | TRUCK |



HALOGEN





SIGNALING AND INTERIOR LAMPS

WEDGE BASE LAMPS

	ECE	Ref. No	V	W	Base	Pieces / PU	Packaging
	(W1,2W)	170403000	24	1.2	W2x4,6d	200	CP
	W3W	171093000	24	3	W2,1x9,5d	200	CP
	W5W	171973000	24	5	W2,1x9,5d	200	CP









SIGNALING AND INTERIOR LAMPS

FESTOON LAMPS

	ECE	Ref. No	V	W	Base	Pieces / PU	Packaging
	T8.2x30	171043000	24	3	SV7,5	200	CP
	C5W	171363000	24	5	SV8,5	200	CP
	T10.5x43	171853000	24	5	SV8,5	200	CP
	T10.5x43	173273000	24	10	SV8,5	200	CP
	T15x43	175223000	24	18	SV8,5	200	CP

SIGNALING AND INTERIOR LAMPS

PLASTIC BASE LAMPS (BAX)

	ECE	Ref. No	V	W	Base	Pieces / PU	Packaging
		170223000	24	1.2	EBS-R4 yellow	200	CP
		170383000	24	1.2	Bax 8,3d grey	200	CP
		170393000	24	1.2	Bax 8,5d grey	200	CP
		170673000	24	1.8	Bax 8,4d blue	200	CP
		170763000	24	1.2	Bax 8,5d brown	200	CP
		170813000	24	1.4	REF29 white	200	CP
		170823000	24	1.4	Bax 8,4d light green	200	CP
		171023000	24	1.2	EBS-R6 brown	200	CP
		171033000	24	1.2	EBS-R white 1,25 mm FR	200	CP
		170723000	24	1.2	EBS-R white frosted	200	CP







24V | TRUCK |

HALOGEN







	ECE	Ref. No	V	W	Base	Pieces / PU	Packaging
	P21W HD	176443000	24	21	BA15s	200	CP
	PY21W HD	176493000	24	21	BAU15s	200	CP
	T4W HD	171433000	24	4	BA9s	200	CP
	R5W HD	171863000	24	5	BA15s	200	CP
	R10W HD	173283000	24	10	BA15s	200	CP

SPARE KITS

In many European countries it's compulsory or recommended to have a spare kit in the vehicle. Our Spare kits provide drivers with the safety they need while on the road or traveling.

	Description	Ref. No	Content	W	Base	N° of pieces
	Spare kit H4	986143010	H4	75/70	P43t	2
			P21W	21	BA15s	6
			R10W	10	BA15s	2
			C10W	10	SV8,5	2
			W5W	5	W2,1x9,5d	2
			Flat fuse			8
			Packing quantity			20
	Spare kit H7	986303010	H7	70	PX26d	2
			P21W	21	BA15s	4
			PY21W	21	BA15s	2
			R10W	10	BA15s	2
			C10W	10	SV8,5	2
			W5W	5	W2,1x9,5d	2
			Flat fuse			3
Packing quantity			20			

SALES TOOLS

	Wall dispenser
	GOC (empty): 990287000
	GOC (filled): 980173000
	Delivered filled with lamps see composition below).
	Resistant metallic housing
	Compact size: 37 x 17.6 x 59.5 cm
	Lockable
	Delivered with
	<ul style="list-style-type: none"> <li>▪ 15x H1</li> <li>▪ 15x H3</li> <li>▪ 10x H4</li> <li>▪ 20x H7</li> <li>▪ 10x P21W</li> <li>▪ 10x PY21W HD</li> <li>▪ 10x R5W</li> <li>▪ 10x R10W</li> <li>▪ 10x T4W</li> <li>▪ 10x W3W</li> <li>▪ 10x W5W</li> <li>▪ 10x W12W</li> <li>▪ 10x C5W</li> </ul>



# TWO-WHEELER 12V LAMPS



NARVA offers the motorcycle lighting for today's demanding riding conditions. Our 12V two-wheelers bulbs provide the visibility and safety the bike riders need.

## WHICH TWO-WHEELER LAMP TYPE DO YOU NEED?

- H1 48320
- H3 (6v) 48301
- H4 48222
- H7 48328
- H8 48076
- H9 48077
- H11 48078
- HB3 48005
- HB4 48006
- HS1 48220
- HS3 -
- HR2 PKR -

- S2 49531
- S3 49014
- M5 P156-25-1 42007
- M5 P156-25-3 42017
- M5 BA20d 42027
- R2 49211

- W3W 17097
- W5W 17177
- W16W 17631
- T2W -
- T4W 17131

- T5W -
- H6W 68161
- R5W 17171
- R10W 17311

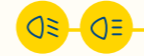

LOW BEAM  
HIGH BEAM



FRONT INDICATORS

- W5W 17177
- W16W 17631
- W21W 17632
- WY21W 17629
- WY5W 17169
- H21W 68191

- R5W 17171
- R10W 17311
- RY10W 17317
- P21W 17635
- P21/5W 17916
- PY21W 17638



REAR PARKING LIGHTS

- R5W 17171
- R10W 17311
- T4W 17131
- H6W 68161
- W3W 17097

- W5W 17177
- W21/5W 17919
- P21W 17635
- P21/5W 17916

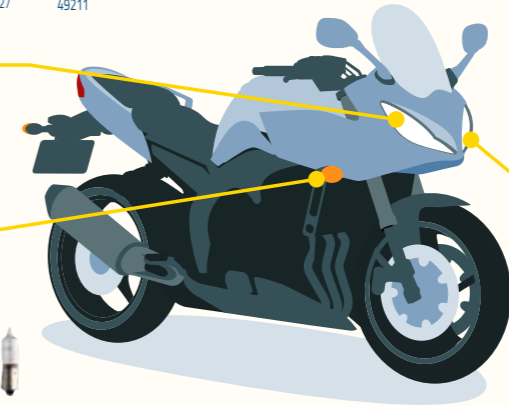

FRONT PARKING LIGHTS



STOP LIGHTS

- P21W 17635
- P21/5W 17916
- R10W 17311

- RY10W 17317
- W16W 17631
- C5W 17125

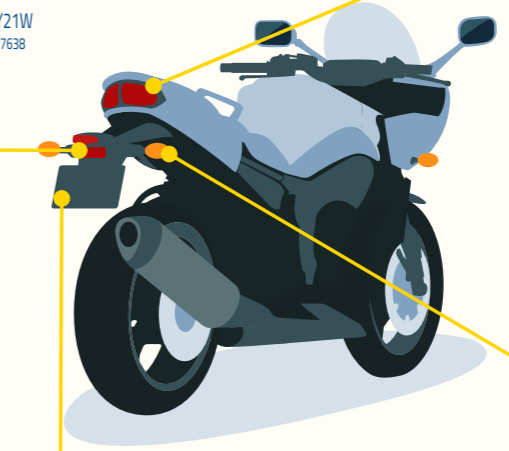

REAR INDICATORS

- W16W 17631
- W21W 17632
- WY21W 17629
- R5W 17171
- R10W 17311



LICENCE PLATE LIGHTS

- R5W 17171
- R10W 17311
- T4W 17131
- W3W 17097
- W5W 17177
- H6W 68161
- C5W 17125

- RY10W 17317
- PY21W 17638
- T3W -
- H6W 68161

## HEADLAMPS

STANDARD

	ECE HS1	Ref. No 482203000	V 12	W 35/35	Base PX43t	Pieces / PU 100	Packaging C1
	ECE H3	Ref. No 483013000	V 6	W 55	Base PK22s	Pieces / PU 100	Packaging C1
	ECE H4 Rallye	Ref. No 482223000	V 12	W 35/35	Base P43t-38	Pieces / PU 100	Packaging C1
	ECE S3	Ref. No 490143000 490043000	V 12 6	W 15 15	Base P26s P26s	Pieces / PU 200 200	Packaging CP CP
	ECE (M5) P15d-25-1	Ref. No 420073000 420053000 420013000	V 12 12 12	W 35/35 25/25 18/18	Base P15d-25-1 P15d-25-1 P15d-25-1	Pieces / PU 100 100 100	Packaging C1 C1 C1
	ECE (M5) P15d-25-3	Ref. No 420173000 420153000	V 12 12	W 35/35 25/25	Base P15d-25-3 P15d-25-3	Pieces / PU 100 100	Packaging C1 C1
	ECE (M5) BA20d	Ref. No 420273000 420253000	V 12 12	W 35/35 25/25	Base BA20d BA20d	Pieces / PU 100 100	Packaging C1 C1

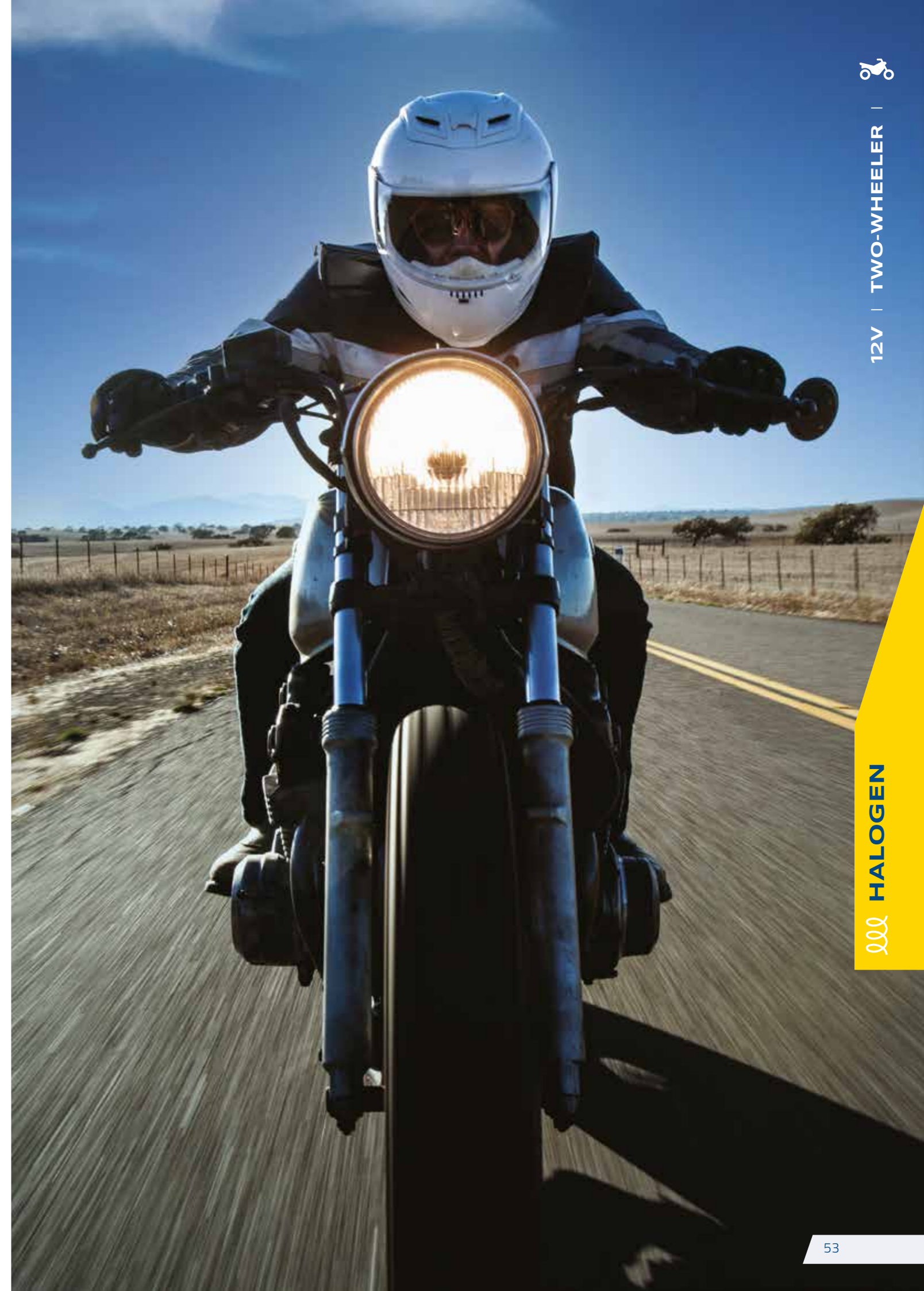

12V | TWO-WHEELER |

HALOGEN



# XENON SOLUTIONS

CAR & TRUCK



- D1S
- D1R
- D2S
- D2R
- D3S
- D3R
- D4S

# XENON LAMPS



## WICH LAMP TYPE DO YOU NEED?



LOW BEAM  
HIGH BEAM



D1S

D1R

D2S







D2R

D3S

D4S

Producing a brilliant, white light and a precise beam, the **NARVA** xenon range offers greater visibility for greater safety.

**NARVA** xenon technology means long lifetime and bright light on the road. Featuring a special UV-blocking quartz glass, this lighting solution provides great visibility maximum safety by allowing drivers to see even farther.

	ECE	Ref. No	V	W	Base	Pieces / PU	Packaging
	D1S	840103000	85	35	PK32d-2	2	C1
	D1R	840113000	85	35	PK32d-3	2	C1
	D2S	840023000	85	35	P32d-2	2	C1
	D2R	840063000	85	35	P32d-3	2	C1
	D3S	840323000	42	35	PK32d-5	2	C1
	D4S	840423000	42	35	P32d-5	2	C1

## UNDERSTANDING XENON LIGHTING SYSTEMS

### Main benefits

- / Brilliant and powerful light projection on the road
- / Light color and intensity close to daylight
- / Extra-long lifetime
- / Low power consumption



Xenon HID (High Intensity Discharge) lamp

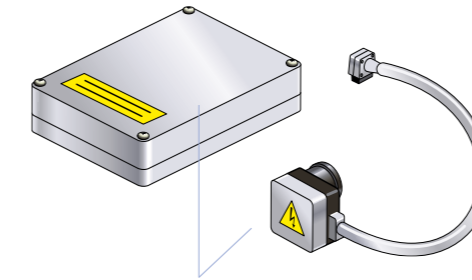

Electronic ballast and high-voltage starter



Complex optical system with automatic level control and power-wash system



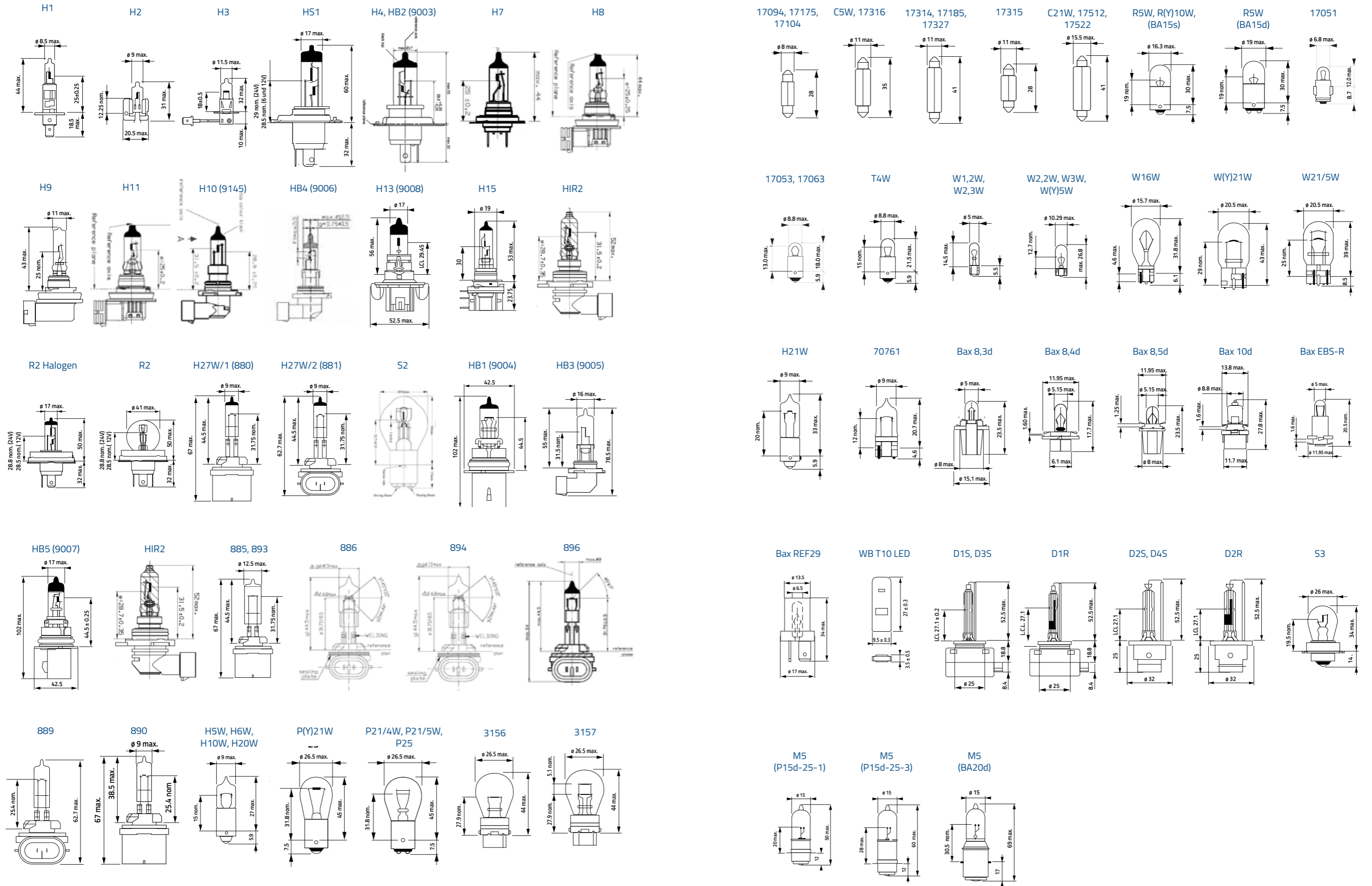

BASES (IEC 60061-1)

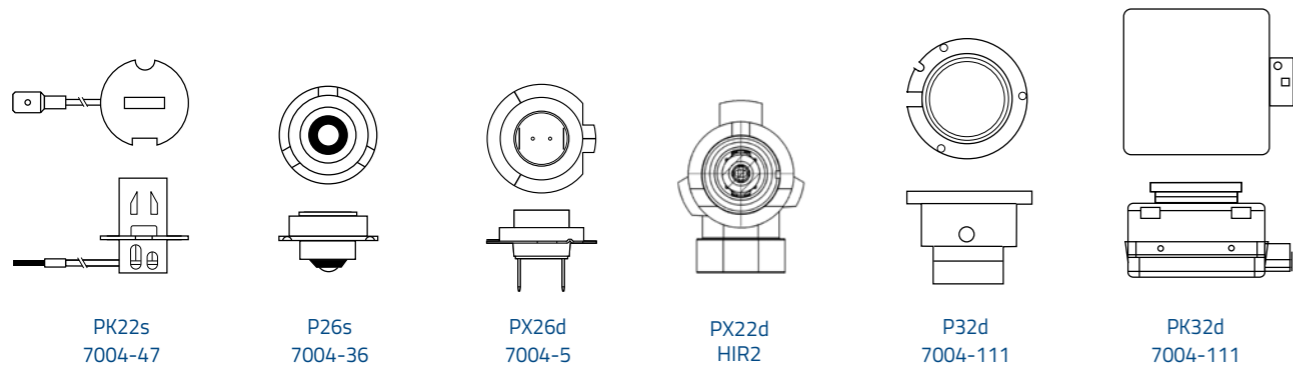
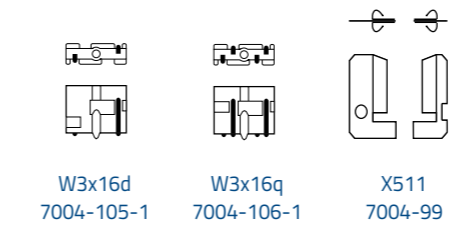
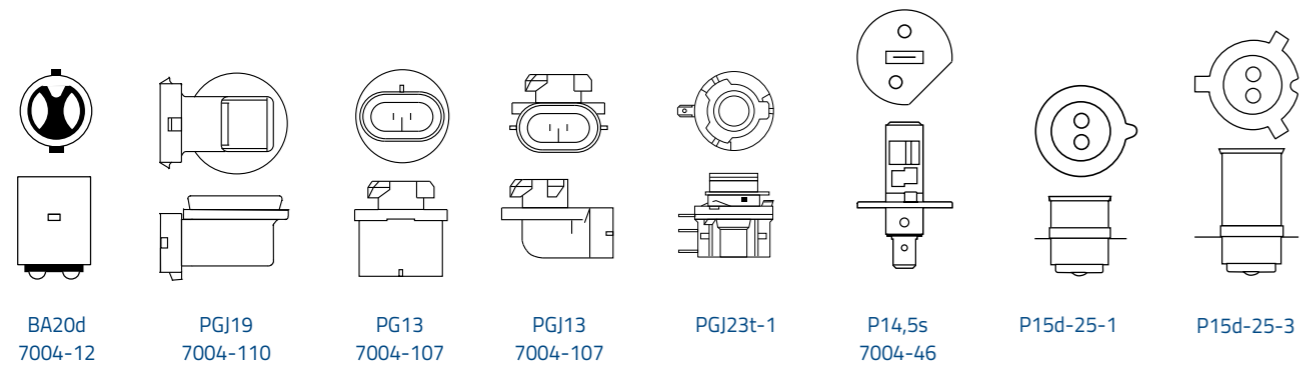
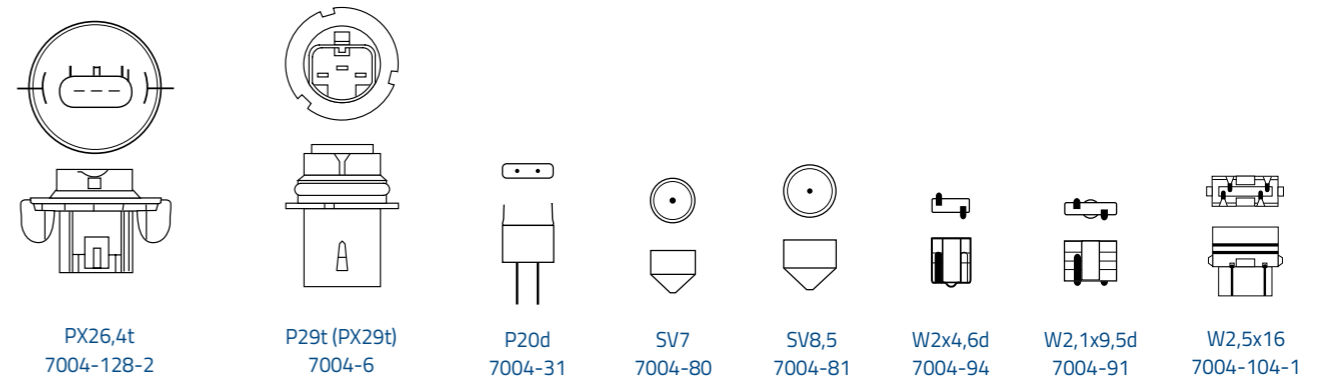
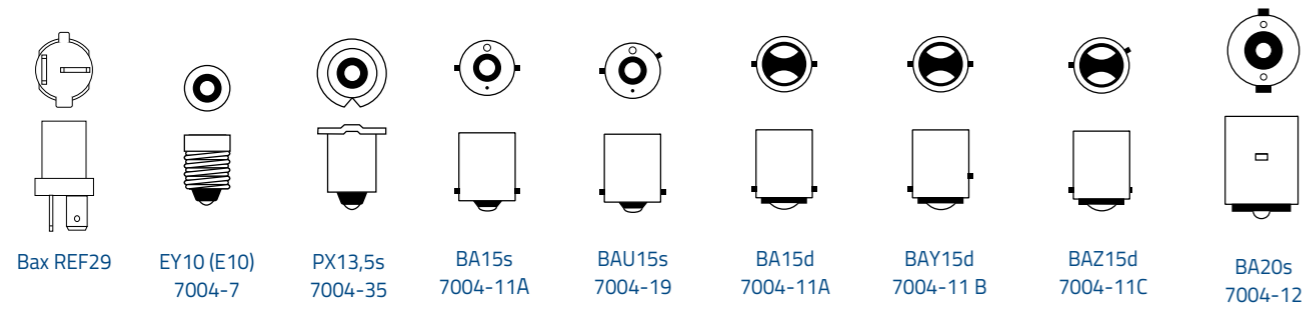
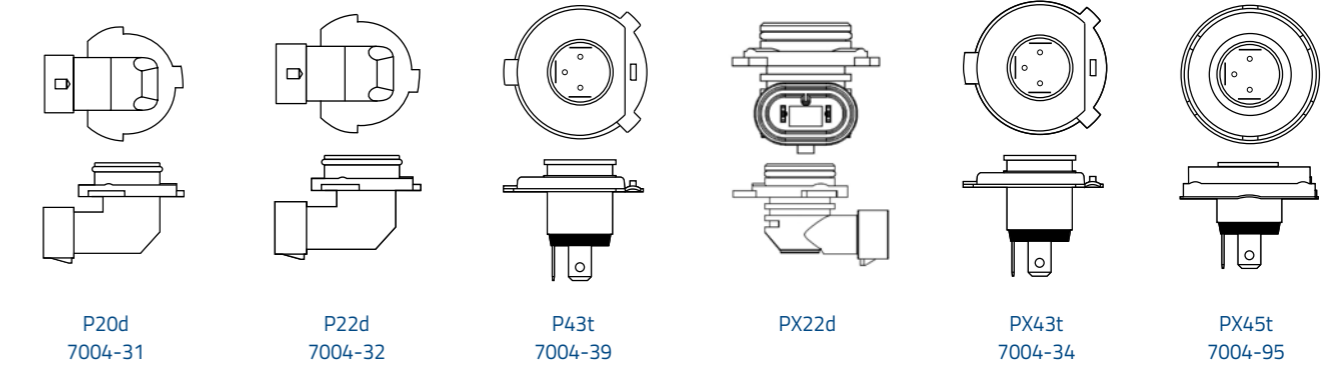
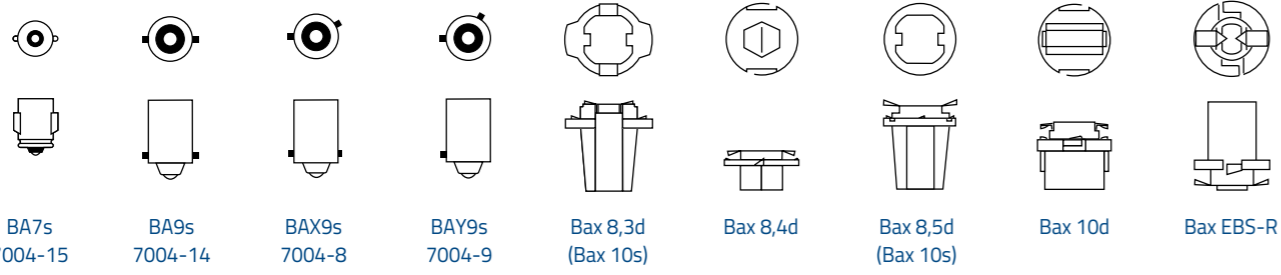





Commercial pack



Blisters



Spare kits

## PACKAGING

### Understanding the NARVA ordering code



488612100

Packaging type code

Ordering code

The attractive packaging design provides a clear view of the products inside and its robust construction protects the content during shipping as well as in-store.

- / Economical
- / Reduces waste
- / Clear information
- / Robust construction

### NARVA Special packaging

Our packaging is used for both Special double packs as well as for Spare kits. Product information is simply and clearly displayed on the back to help consumers make an informed decision.



C1/CP  
Commercial pack  
**3000**



S2/SM  
Special double pack  
**2100**



B1/B2  
Single blister / Double blister  
**4000**



Special double pack  
for LED  
**3000**

### Abbreviations for range names

- HD** Heavy Duty  
Resists all vibrations
- LL** Long Life  
Double lifetime
- RA** Rallye\*  
Extreme brightness
- RP50+** Range Power 50+  
Up to 50% more vision
- RP150** Range Power 150  
Up to 150% more brightness

- RPB+** Range Power Blue+  
Up to 50% more vision,  
stylish white
- RPW** Range Power White\*  
4500 K Xenon white
- RPLED** Range Performance LED\*\*  
Up to 6500 K, crisp, white light

\*Important Products that do not carry the ECE certification logo are not homologated and cannot be sold in Europe.



\*\*It is your own responsibility to ensure that the use of the LED retrofit lights complies with applicable local legal requirements.



# **NARVA**

**D A S L I C H T**

**Lumileds Germany GmbH**

Philipsstraße 8  
52068 Aachen  
Germany

Tel. +49 (0)3741 746 8181  
E-mail: [info@narva-light.com](mailto:info@narva-light.com)  
[www.narva-light.com](http://www.narva-light.com)

© 2022 Lumileds Holding B.V.  
EN-EN • 2022

Member of **NARVA e.V. Germany** ///