

NARVA
DAS LICHT



OTOMOTIV AYDINLATMASI

2024 Katalođu

İÇİNDEKİLER

LED

12/24V OTOMOBİL VE KAMYON



NE TÜR BİR LED YÜKSELTMESİNE İHTİYACINIZ VAR?	08
FARLAR	
Range Performance Advanced LED	11

SİNYALLER VE İÇ AYDINLATMA	
Range Performance LED	12

GELENEKSEL AMPULLER

12V OTOMOBİL



NASIL BİR 12V LAMBAYA İHTİYACINIZ VAR?	20
FARLAR	
Standard	23
Long Life	25
Range Power 50+	26
Range Power 150	26
Range Power Blue+	27
Range Power White	28
Rallye	29
Amerikan tipleri	30

SİNYALLER VE İÇ AYDINLATMA	
Sinyal lambaları	32
Halojen minyatür lambalar	34
Kama tabanlı lambalar	34
Feston lambalar	35
Plastik tabanlı lambalar (Bax)	36
Range Power Blue+	37
YEDEK KİTLERİ	40
SATIŞ ARAÇLARI	41

24V KAMYON



NASIL BİR 24V LAMBAYA İHTİYACINIZ VAR?	43
FARLAR	
Standard	44
Heavy Duty	45
Rallye	45
SİNYALLER VE İÇ AYDINLATMA	
Sinyal lambaları	46

Halojen minyatür lambalar	47
Kama tabanlı lambalar	48
Feston lambalar	48
Plastik tabanlı lambalar (Bax)	49
Heavy Duty	50
YEDEK KİTLERİ	51
SATIŞ ARAÇLARI	52

12V İKİ TEKERLEKLİ ARAÇ



NASIL BİR İKİ TEKERLEKLİ ARAÇ LAMBASINA İHTİYACINIZ VAR?	53
FARLAR	
Standard	54

FARLAR	
Standard	54

XENON

OTOMOBİL VE KAMYON



HANGİ XENON LAMBAYA İHTİYACINIZ VAR?	59
FARLAR	
Standard	61

FARLAR	
Standard	61

TEKNİK ÇİZİMLER	62
TABANLAR (IEC 60061-1)	64
AMBALAJ	66

OTOMOTIV AYDINLATMASI UZMANI



NARVA hakkında daha fazla bilgi için lütfen
WWW.NARVA-LIGHT.COM
web sitemizi ziyaret edin

MÜŞTERILERİMİZ ÖNCELİKLİDİR

Müşteri memnuniyeti NARVA'da en yüksek önceliğimizdir. NARVA'nın sunduğu yüksek kalitede otomotiv aydınlatma ürünleriyle profesyoneller, müşterilerinin ihtiyaçlarını eksiksiz bir şekilde karşılayabilir.

Garaj ve mağazalar, NARVA ile güvenilir ürünleri ve kaliteli hizmeti ekonomik bir fiyata sunabilir. NARVA, dünyanın dört bir yanındaki profesyonellerin ihtiyaçlarını karşılamak amacıyla kapsamlı bir ürün portföyü geliştirmiştir.

Özel NARVA ekipleri ve distribütörleri, dünyanın her yerindeki müşterilerimize hizmet ve bilgi sunmaya odaklanmıştır. Faaliyet gösterdiğimiz alanların tümünde müşteri ve piyasa taleplerini etkin ve verimli biçimde karşılamak üzere çaba gösteririz.

UYGUN FİYATLI KALITEMİZ

- / NARVA, otomotiv aydınlatmasında 70 yılı aşkın deneyim
- / Üretim sürecinin tamamında uygulanan kapsamlı testler
- / Her lamba için sabit kalite kontrolü
- / IATF 16949, DIN EN ISO 14001, ECE R37, ECE R99 standartlarını da kapsayan uyumluluk testi ve uluslararası sertifika süreçleri
- / Ürün yenilikçiliğine ve yeni süreçlere sürekli yatırım

NARVA ürünlerinin ve üretim süreçlerinin kalitesi düzenli olarak denetlenir. Ürünlerimiz ECE* yönetmeliklerine uyar ve diğer yasal gereklilikleri karşılar. (ECE sertifikalı aydınlatma ürünlerinin tamamını görmek için sayfa 2'deki Nasıl bir aydınlatma çözümüne ihtiyacınız var? konusunu inceleyin.) NARVA üretimin yanı sıra, pazarlama ve lojistik süreçleri de, günümüzün uluslararası IATF standartları çerçevesinde düzenli biçimde denetlenmektedir. Otomotiv endüstrisi ve tedarikçileri için ECE tarafından oluşturulan uluslararası yönergeler, tiOTOMOBİLİ engelleri azaltmayı ve trafik güvenliğini artırmayı hedeflemektedir. ECE yönetmeliklerine uygun

Satış ofislerimiz, merkezi depomuzla birlikte detaycı bir müşteri desteği ve etkin bir teslim hizmeti sunmaktadır. Özel NARVA ekipleri ve distribütörleri, faaliyet gösterdiğimiz alanların tümünde mükemmel bir müşteri hizmeti sağlamaya odaklanmıştır.

Müşteri hizmeti, kaliteli bir ürünü ekonomik bir fiyata sunmakla başlar. Günümüzün giderek yoğunlaşan yollarında, daha fazla emniyet ve görünürlük için tüm sürücülerin kaliteli ve güvenilir bir aydınlatma çözümüne ekonomik olarak sahip olabilmemesinin gerekli olduğunu düşünüyoruz.

ARTIK HERKES KALITELİ AYDINLATMAYI EKONOMİK OLARAK ELDE EDEBİLECEK.

olmayan ürünler Avrupa'da satılmaz. NARVA ürünleri, filamanlı lambalar için ECE 37 düzenlemelerine ve gaz boşalmalı lambalar için 99 düzenlemelerine tabidir. Bunlar; ölçümler, ışık akışı ve güce yönelik kuralları içerir. ISO/TS 16949 uyumluluğumuz; üretim, pazarlama ve lojistik süreçlerimizdeki emniyet ve denge entegrasyonunun göstergesidir. NARVA aydınlatma çözümlerini asıl tanımlayan 70 yılı aşkın deneyim ve bilgi birikimidir. NARVA, sabit kaliteyi yaygınlaştırmak ve yerleştirmek amacıyla otomotiv aydınlatma ürünlerinde sürekli testler uygulamaktadır. Tüm kalite testlerinde sağlanan uyumluluk NARVA ürünlerinin tamamı için güvenilirliği garanti eder.

*ECE = Economic Commission for Europe (Avrupa Ekonomik Komisyonu)

LED YÜKSELTME ÇÖZÜMLERİ



RANGE PERFORMANCE ADVANCED LED



HL [≈H1]
HL [≈H3]
HL [≈H4/H19]
HL [≈H7/H18]
HL [≈H11/H9]
FL [≈H8/H11/H16]
HL [≈HB3/HB4]
HL [≈HIR2]

LED retrofit ışıkların kullanımının geçerli yasal gereksinimlere uygun olmasının sorumluluğu size aittir.



NE TÜR BİR LED YÜKSELTMESİNE İHTİYACINIZ VAR?



İÇ İŞIKLAR TÖRPİDO GÖZÜ İŞIĞI

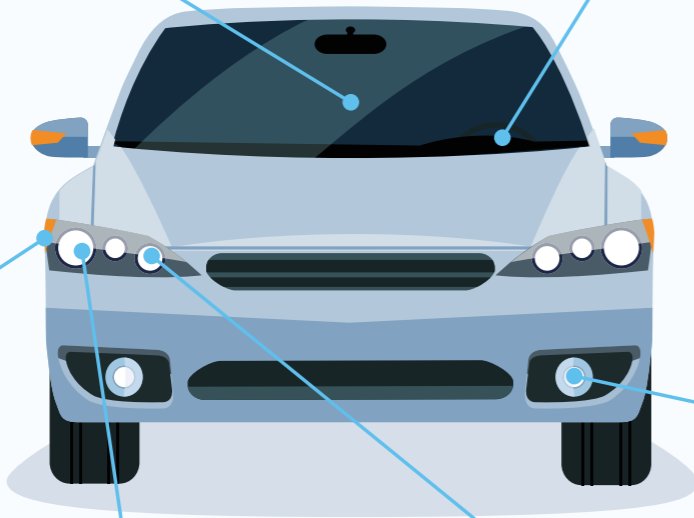

GÖSTERGE KADRANI İŞIKLARI



ÖN GÖSTERGELER



KISA FAR UZUN FAR



ÖN SIS FARLARI



ÖN PARK LAMBALARI

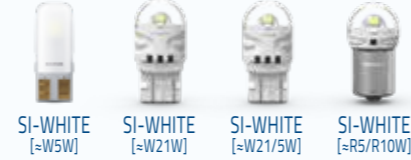

3. STOP LAMBASI



RKA GÖSTERGELER

PLAKA İŞIKLARI



BAGAJ İŞIKLARI



GERİ MANEVRA İŞIĞI



ARKA SIS FARLARI



STOP LAMBALARI ARKA PARK LAMBALARILIGHTS



LED

12/24 V LAMBALAR





LED retrofit ampuller, sürücüler için yolda büyük ölçüde daha iyi görüş imkanı ve geceleri ya da olumsuz hava koşullarında gelişmiş güvenlik sunar. Geleneksel ampullere kıyasla daha az güç tüketir, böylece enerji tüketimini azaltır ve aracın akü ömrünü uzatabilir. Ayrıca daha uzun kullanım ömürleri sayesinde LED ampuller, değiştirme sıklığını azaltarak sürücüler için uygun maliyetli bir aydınlatma çözümü sunar.

FARLAR

RANGE PERFORMANCE ADVANCED

- Halojen ampuller için ECE R112 minimumuna kıyasla +%100 daha fazla ışık
- Gölge oluşturmadan 320° ışık yayılımı için kenarsız kapsül tasarımı
- Optimum ışık demeti deseni ve süper odaklı ışık demeti
- 6000 K soğuk beyaz ışık
- Çift ısı yönetimi teknolojisiyle 2000 saate kadar kullanım ömrü
- 12 V ve 24 V elektrik sistemleriyle uyumludur

Tipi	Ref. No	V	W	Taban	Parça/Paket	Ambalaj
 HL [≈H1]	181818100	12/24	19	P14,5s	6	X2
 HL [≈H3]	181828100	12/24	19	PK22s	6	X2
 HL [≈H4/H19]	181878100	12/24	19	PX26d / PY26d-1	6	X2
 HL [≈H7/H18]	181838100	12/24	19	PX26d / PY26d-1	6	X2
 HL [≈H11/H9]	181848100	12/24	19	PGJ19-2/5	6	X2
 FL [≈H8/H11/H16]	182188100	12/24	19	PGJ19-1/2/3	6	X2
 HL [≈HB3/HB4]	181858100	12/24	19	P20d/P22d	6	X2
 HL [≈HIR2]	181868100	12/24	19	PX22d	6	X2

- Şık 6000 K soğuk beyaz ve yoğun renk tonları
- Yüksek performanslı LED çipleri
- LED standart kapakları sayesinde tak ve çalıştır kurulum
- Polaritesiz tasarım (W5W, Fest 38 mm, Fest 43 mm hariç)
- 3000 saate kadar kullanım ömrü
- 12 V nominal

Tipi	Ref. No	V	W	Taban	Parça/Paket	Ambalaj
 SI-WHITE [≈W5W]	181454100	12	0.36	W2.1x9.5d	6	B2

Tipi	Ref. No	V	W	Taban	Parça/Paket	Ambalaj
 SI-WHITE [≈P21W]	181484100	12	2.20	BA15S	6	B2

Tipi	Ref. No	V	W	Taban	Parça/Paket	Ambalaj
 SI-WHITE [≈W21W]	180844100	12	2.20	W3x16d	6	B2

Tipi	Ref. No	V	W	Taban	Parça/Paket	Ambalaj
 SI-AMBER [≈PY21W]	181494100	12	2.15	BAY15D	6	B2

Tipi	Ref. No	V	W	Taban	Parça/Paket	Ambalaj
 SI-AMBER [≈WY21W]	181464100	12	2.15	WX3x16d	6	B2

Tipi	Ref. No	V	W	Taban	Parça/Paket	Ambalaj
 SI-RED [≈P21W]	181514100	12	1.73	BA15S	6	B2

Tipi	Ref. No	V	W	Taban	Parça/Paket	Ambalaj
 SI-RED [≈W21W]	180874100	12	1.73	W3x16d	6	B2

Tipi	Ref. No	V	W	Taban	Parça/Paket	Ambalaj
 SI-WHITE [≈P21/5W]	181474100	12	2.4/0.48	BAY15D	6	B2

Tipi	Ref. No	V	W	Taban	Parça/Paket	Ambalaj
 SI-WHITE [≈W21/5W]	180884100	12	2.4/0.48	W3x16q	6	B2

Tipi	Ref. No	V	W	Taban	Parça/Paket	Ambalaj
 SI-RED [≈P21/5W]	181524100	12	1.75/0.65	BAY15D	6	B2

Tipi	Ref. No	V	W	Taban	Parça/Paket	Ambalaj
 SI-RED [≈W21/5W]	181694100	12	1.75/0.65	W3x16q	6	B2

Tipi	Ref. No	V	W	Taban	Parça/Paket	Ambalaj
 SI-WHITE [≈Fest 30 mm]	181704000	12	0.80	SV8.5	6	B1



Tipi	Ref. No	V	W	Taban	Parça/Paket	Ambalaj
 SI-WHITE [≈Fest 38 mm]	181714000	12	0.60	SV8.5	6	B1

Tipi	Ref. No	V	W	Taban	Parça/Paket	Ambalaj
 SI-WHITE [≈Fest 43 mm]	181724000	12	0.60	SV8.5	6	B1







Tipi	Ref. No	V	W	Taban	Parça/Paket	Ambalaj
 SI-WHITE [≈W16W]	181644000	12	1.80	W2.1x9.5d	6	B1

Tipi	Ref. No	V	W	Taban	Parça/Paket	Ambalaj
 SI-WHITE [≈R5/R10W]	181654100	12	1.80	BA15s	6	B2

- Hatalı gösterge paneli uyarılarını önler
- Titreme ve kararma sorunlarını ortadan kaldırır

Tipi	Ref. No	V	Parça/Paket	Ambalaj
 H7	182528100	12	2	X2
 H4	182538100	12	2	X2
 H11/FOG	182548100	12	2	X2
 HB3/HB4 HIR2	182558100	12	2	X2
 W5W	181318100	12	2	X2

- H7 LED tipi lambaların belirli araçlara sorunsuz bir şekilde monte edilmesini sağlar
- Her tip, belirli araç modellerine uygundur. Aracınıza uygun halka tipini bulmak için uyumluluk listemize göz atın.

Tipi	Ref. No	Parça/Paket	Ambalaj
 Type H	182448100	6	X2
 Type D	182458100	6	X2
 Type E	182468100	6	X2
 Type P	182478100	6	X2
 Type K	182488100	6	X2
 Type I	182498100	6	X2
 Type N	182518100	6	X2



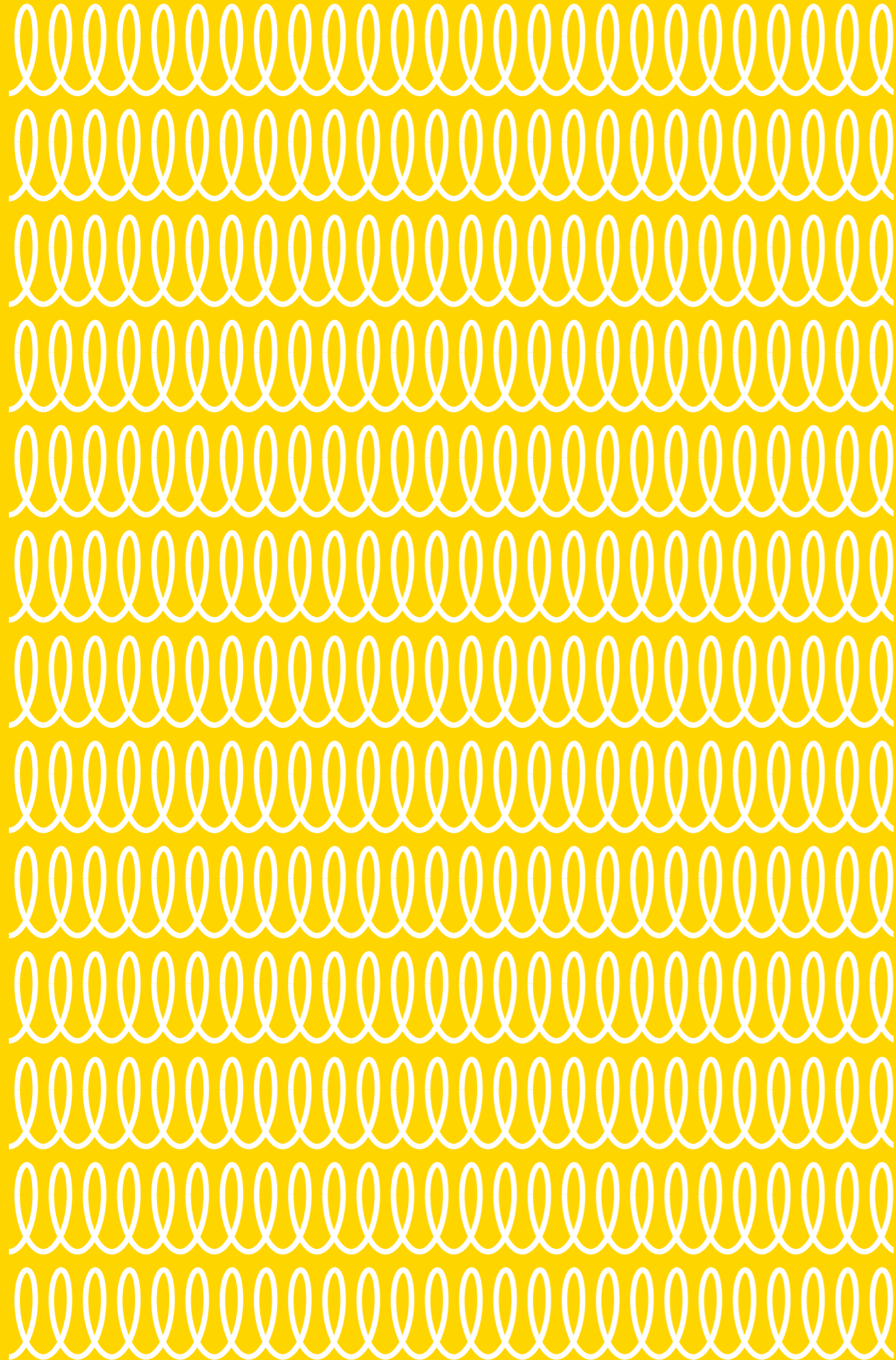







GELENEKSEL AMPULLER

OTOMOBİL



DEĞİŞTİRME	DAYANIKLILIK	DAHA İYİ GÖRÜŞ		STİL OLUŞTURMA		
Standard — Paranın tam karşılığı —	Long Life — İki kat kullanım ömrü —	Range Power 50+ — %50'ye kadar daha fazla görüş —	Range Power 150 — %50'ye kadar daha fazla parlaklık —	Range Power Blue+ — %50'ye kadar daha fazla görüş, Şık beyaz —	Range Power White — 4500 K Xenon beyazı —	Rallye — Mükemmel parlaklık —
						
					ECE onaylı değildir*	ECE onaylı değildir*

KAMYON



DEĞİŞTİRME	DAYANIKLILIK	STİL OLUŞTURMA
Standard — Paranın tam karşılığı —	Heavy Duty — Her türlü titreşime dayanıklı —	Rallye — Mükemmel parlaklık —
		
		ECE onaylı değildir*

*Önemli: ECE sertifikası logosunu taşımayan ürünler onaylı değildir ve Avrupa'da satılamaz.

GELENEKSEL AMPULLER

DEĞİŞTİRME

STANDARD

NARVA Standard, ekonomiyle güvenilirliği bir araya getirerek en iyi değeri sunar. Güvenlikten ödün vermeden en iyi fiyat/performans oranını isteyen sürücüler için NARVA Standard doğru seçimdir.



DAYANIKLILIK

LONG LIFE

Yeşil serimiz özellikle uzun kullanım ömrü için tasarlanmıştır. Standart lambalara göre iki kat dayanıklı olan bu uzun ömürlü lambalar sık değişim gerektirmez, bu da daha az bakım ve çevrede en alt düzeyde olumsuz etkiye neden olur.



DAHA İYİ GÖRÜŞ

RANGE POWER 50+



RANGE POWER 50+

Standart bir lambaya göre %50'ye kadar daha fazla görüş sunan Range Power 50+, daha da fazla parlaklık için daha uzun bir ışık ışını sağlar. 2 kat kullanım ömrü sağlamanın yanı sıra, daha yüksek güvenlik için daha uzağı daha net görmek isteyen sürücüler için tasarlanmıştır.



RANGE POWER 150



RANGE POWER 150

Yeni Range Power 150, %150'ye daha fazla parlaklık. Güçlü ışık ışını sürücülerin daha uzağı görmesine olanak tanır. Özel yakıcı tasarımı, daha fazla güvenlik ve daha yüksek performans sağlamak üzere daha fazla lümen çıkışı oluşturur.



STİL OLUŞTURMA

RANGE POWER BLUE+



RANGE POWER BLUE+

%50'ye kadar daha fazla görüş ve %30 daha şık ve soğuk ışık sunan Range Power Blue+ serimiz, daha fazla görüş ve güvenlik adına daha uzağı daha net görmek isteyen sürücüler için tasarlanmıştır. Şık mavi efekt diğerleri arasında aracı görünür kılar.



RANGE POWER WHITE



RANGE POWER WHITE*

NARVA Range Power White parlak ve şık bir beyaz ışık sunar. 4500 K renk sıcaklığıyla elde edilen şık xenon efekti, aracınıza gün ışığına yakın dikkat çekici bir görünüm sağlar. Range Power White başkalarının arasında farklı görünmek isteyenlerin tercihidir.



RALLYE

RALLYE*

Daha fazla görünürlük için yüksek güç sağlayan Rallye serisi, sürücülerin daha uzağı daha net şekilde görmesini sağlar.

*ECE onaylı değildir. Avrupa'da satılamaz veya kullanılamaz.



NASIL BİR 12V LAMBAYA İHTİYACINIZ VAR?



TORPIDO GÖZÜ İŞİĞİ



İÇ İŞIKLAR



GÖSTERGE KADRANI İŞIKLARI

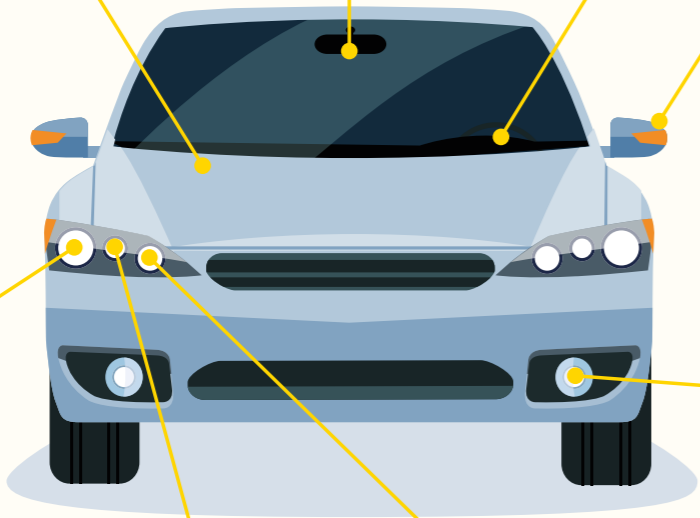

YAN GÖSTERGELER



**KISA FAR
UZUN FAR
LED GÜNDÜZ FARLARI**

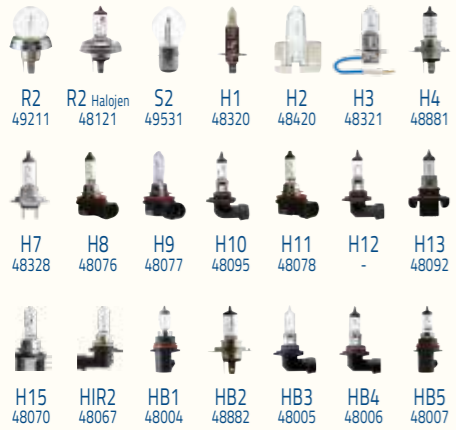

ÖN GÖSTERGELER



ÖN PARK LAMBALARI



ÖN SIS FARLARI



800 series



3. STOP LAMBASI



PLAKA İŞIKLARI



BAGAJ İŞIKLARI



ARKA SIS FARLARI



GERİ MANEVRA İŞİĞİ

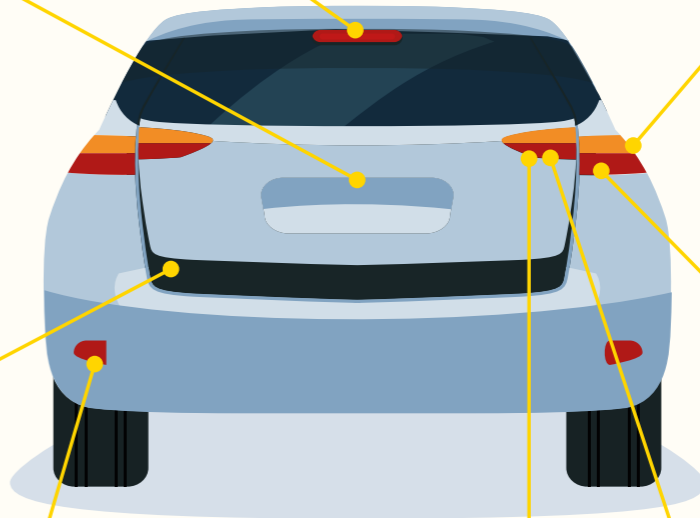

REVERSING LIGHTS



ARKA PARK LAMBALARI



ARKA SIS FARLARI



STOP LAMBALARI



OTOMOBİL

12 V LAMBALAR

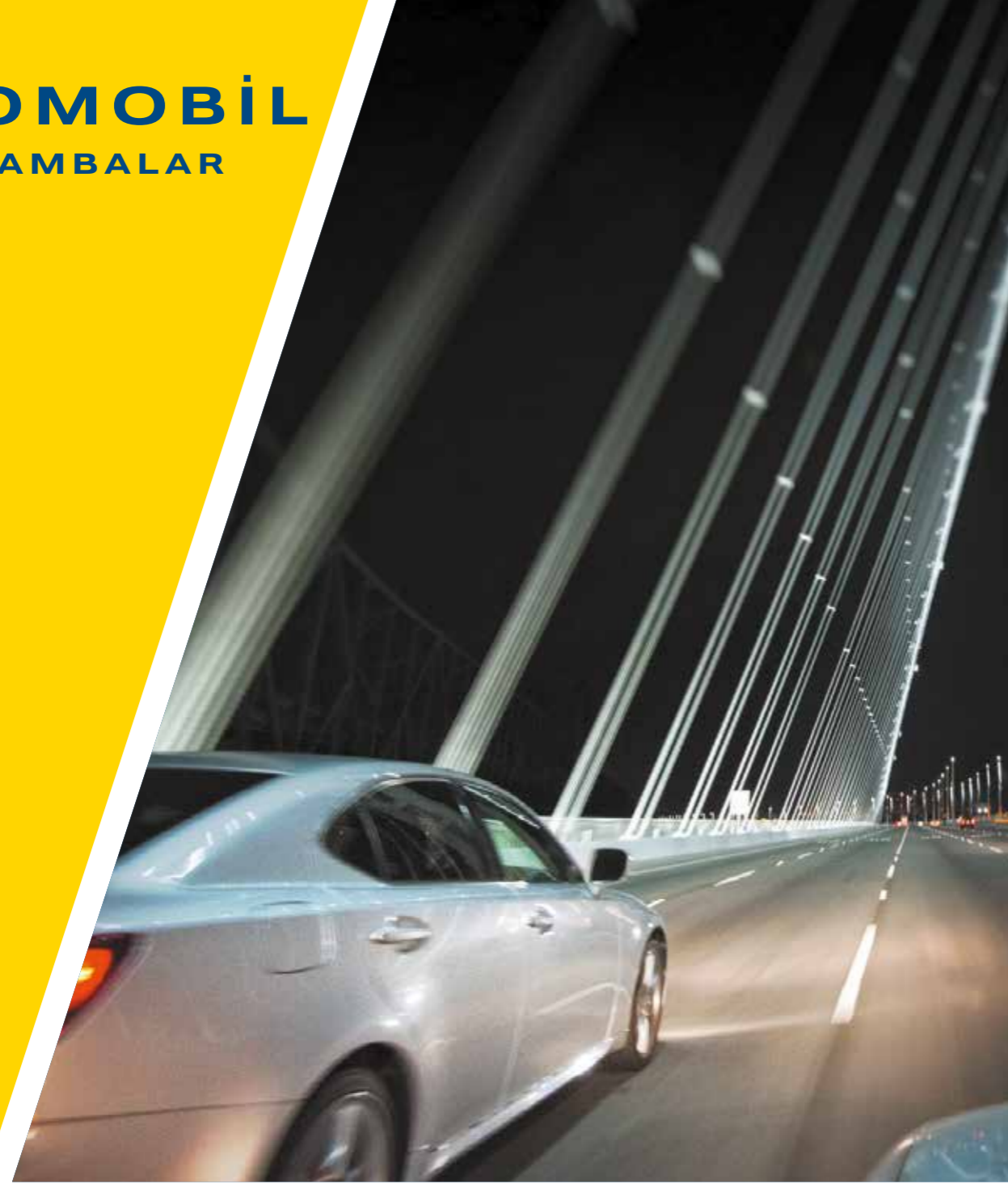











NARVA; dayanıklı, güvenilir ve kaliteli HaloGen aydınlatma çözümleri üretmesiyle tanınır.

HaloGen ampullerimiz, tüm sürüş koşullarında daha fazla görünürlük ve daha fazla güvenlik sağlar.

FARLAR

STANDARD

	ECE	Ref. No	V	W	Taban	Parça/Paket	Ambalaj
	H1	483203000 483204000	12 12	55 55	P14,5s P14,5s	100 10	C1 B1
	H2	484203000	12	55	X511	100	C1
	H3	483213000 483214000	12 12	55 55	PK22s PK22s	100 10	C1 B1
	H4	488813000 488814000	12 12	60/55 60/55	P43t P43t-38	100 10	C1 B1
	H7	483283000 483284000	12 12	55 55	PX26d PX26d	100 10	C1 B1
	H8	480763000	12	55	PGJ19-1	100	C1
	H9	480773000	12	65	PGJ19-5	100	C1
	H10 (9145)	480953000	12	42	PY20d	100	C1
	H11	480723000	12	55	PGJ19-2	100	C1
	H13 (9008)	480923000	12	60/55	P26,4t	100	C1



FARLAR

STANDARD

ECE	Ref. No	V	W	Taban	Parça/Paket	Ambalaj
H15	480703000	12	15/55	PGJ23t-1	100	C1
HIR2	480673000	12	55	PX22d	100	C1
R2 Halojen	481213000	12	45/40	P45t-41	100	C1
R2	492113000	12	45/40	P45t	100	C1
H27W/1	480413000	12	27	PG13	100	C1
H27W/2	480423000	12	27	PG13	100	C1
S2	495313000	12	35/35	BA20d	200	C1
HB1	480043000	12	65/45	P29t	100	CP
HB2	488823000	12	67/60	P43t-38	100	C1
HB3	480053000 480054000	12 12	60 60	P20d P20d	100 10	C1 B1



ECE	Ref. No	V	W	Taban	Parça/Paket	Ambalaj
HB4	480063000 480064000	12 12	51 51	P22d P22d	100 10	C1 B1



ECE	Ref. No	V	W	Taban	Parça/Paket	Ambalaj
HB5	480073000	12	65/55	PX29t	100	C1

FARLAR

LONG LIFE

ECE	Ref. No	V	W	Taban	Parça/Paket	Ambalaj
H1 LL	483223000	12	55	P14,5s	100	C1
H4 LL	488893000	12	60/55	P43t-38	100	C1
H7 LL	483293000	12	55	PX26d	100	C1
H11 LL	480783000	12	55	PGJ19-2	100	C1
862 LL	480595000	12	37.5	PGJ13	300	CP



FARLAR

RANGE POWER 50+

ECE	Ref. No	V	W	Taban	Parça/Paket	Ambalaj
H1	483343000	12	55	P14,5s	100	C1
RP50+	483344000	12	55	P14,5s	10	B1
	483342100	12	55	P14,5s	10	S2

ECE	Ref. No	V	W	Taban	Parça/Paket	Ambalaj
H3	483353000	12	55	PK22s	100	C1
RP50+						

ECE	Ref. No	V	W	Taban	Parça/Paket	Ambalaj
H4	488613000	12	60/55	P43t-38	100	C1
RP50+	488614000	12	60/55	P43t-38	10	B1
	488612100	12	60/55	P43t-38	10	S2

ECE	Ref. No	V	W	Taban	Parça/Paket	Ambalaj
H7	483393000	12	55	PX26d	100	C1
RP50+	483394000	12	55	PX26d	10	B1
	483392100	12	55	PX26d	10	S2

FARLAR

RANGE POWER 150

ECE	Ref. No	V	W	Taban	Parça/Paket	Ambalaj
H1	480682100	12	55	P14,5s	10	S2
RP150						

ECE	Ref. No	V	W	Taban	Parça/Paket	Ambalaj
H4	480692100	12	60/55	P43t-38	10	S2
RP150						

ECE	Ref. No	V	W	Taban	Parça/Paket	Ambalaj
H7	480712100	12	55	PX26d	10	S2
RP150						

ECE	Ref. No	V	W	Taban	Parça/Paket	Ambalaj
H11	481012100	12	55	PGJ19-2	10	S2
RP150						

FARLAR

RANGE POWER BLUE+

ECE	Ref. No	V	W	Taban	Parça/Paket	Ambalaj
H1	486303000	12	55	P14,5s	100	C1
RPB+	486304000	12	55	P14,5s	10	B1
	486302100	12	55	P14,5s	10	S2

ECE	Ref. No	V	W	Taban	Parça/Paket	Ambalaj
H3	486333000	12	55	PK22s	100	C1
RPB+						

ECE	Ref. No	V	W	Taban	Parça/Paket	Ambalaj
H4	486773000	12	60/55	P43t-38	100	C1
RPB+	486774000	12	60/55	P43t-38	10	B1
	486772100	12	60/55	P43t-38	10	S2

ECE	Ref. No	V	W	Taban	Parça/Paket	Ambalaj
H7	486383000	12	55	PX26d	100	C1
RPB+	486384000	12	55	PX26d	10	B1
	486382100	12	55	PX26d	10	S2

ECE	Ref. No	V	W	Taban	Parça/Paket	Ambalaj
HB2	486763000	12	67/60	P43t-38	100	C1
RPB+						

ECE	Ref. No	V	W	Taban	Parça/Paket	Ambalaj
HB3	486163000	12	60	P20d	100	C1
RPB+						

ECE	Ref. No	V	W	Taban	Parça/Paket	Ambalaj
HB4	486133000	12	51	P22d	100	C1
RPB+						

ECE	Ref. No	V	W	Taban	Parça/Paket	Ambalaj
HB5	486293000	12	65/55	PX29t	100	C1
RPB+						



12V | OTOMOBİL

GELENEKSEL
AMPULLER

FARLAR

RANGE POWER WHITE*

Tipi	Ref. No	V	W	Taban	Parça/Paket	Ambalaj
H1 RPW	486412100	12	55	P14,5s	10	S2
H3 RPW	486022100	12	55	PK22s	10	S2
H4 RPW	486802100	12	60/55	P43t-38	10	S2
H7 RPW	486072100	12	55	PX26d	10	S2
HB3 (9005) RPW	486252100	12	65	P20d	10	S2
HB4 (9006) RPW	486262100	12	55	P22d	10	S2
H1/W5W PW kit	980142100	H1 W5W	85 5	P14,5s W2,1x9,5d	2 2	SM
H4/W5W PW kit	980152100	H4 W5W	100/90 5	P43t W2,1x9,5d	2 2	SM
H7/W5W PW kit	980162100	H7 W5W	85 5	PX26d W2,1x9,5d	2 2	SM

*Önemli: ECE sertifikası logosunu taşımayan ürünler onaylı değildir ve Avrupa'da satılamaz.

FARLAR

RALLYE*

Tipi	Ref. No	V	W	Taban	Parça/Paket	Ambalaj
H1 Rallye	483503000 483803000	12 12	100 130	P14,5s P14,5s	100 100	C1 C1
H3 Rallye	483513000 483813000	12 12	100 130	PK22s PK22s	100 100	C1 C1
H4 Rallye P43t	489013000 489014000 489113000 489513000	12 12 12 12	100/90 100/90 100/55 130/100	P43t-38 P43t-38 PX26d P43t	100 10 100 100	C1 B1 C1 C1
H4 Rallye P45t	488843000 489043000	12 12	60/55 100/90	P45t P45t-41	100 100	C1 C1
H7 Rallye	483583000	12	80	PX26d	100	C1
HB1 Rallye	480343000	12	100/80	P29t	100	C1
HB3 Rallye	480253000	12	100	P20d	100	C1
HB4 Rallye	480263000	12	70	P22d	100	C1
HB5 Rallye	480313000	12	100/80	PX29t	100	C1

*Önemli: ECE sertifikası logosunu taşımayan ürünler onaylı değildir ve Avrupa'da satılamaz.



Amerikan Tipi	Ref. No	V	W	Taban	Parça/Paket	Ambalaj
9004 (HB1)	480043000	12	65/45	P29t	100	CP
9003 (HB2)	488823000	12	67/60	P43t-38	100	C1
9005 (HB3)	480053000 480054000	12 12	60 60	P20d P20d	100 10	C1 B1
9006 (HB1)	480063000 480064000	12 12	51 51	P22d P22d	100 10	C1 B1
9007 (HB5)	480073000	12	65/45	PX29t	100	C1
9008 (H13)	480923000	12	60/55	P26,4t	100	C1
9145 (H10)	480953000	12	42	Y20d	100	C1
880	480393000	12.8	27	PG13	100	C1
881	480403000	12.8	27	PGJ13	100	C1
885	480553000	12.8	50	PG13	100	C1





Amerikan Tipi	Ref. No	V	W	Taban	Parça/Paket	Ambalaj
886	480563000	12.8	50	PGJ13	100	C1
889	480453000	12.8	27	PGJ13	100	C1
890	480463000	12.8	27	PG13	100	C1
893	480513000	12.8	37.5	PG13	100	C1
894	480543000	12.8	37.5	PGJ13	100	C1
896	480523000	12.8	37.5	PGJ13	100	C1















SİNYALLER VE İÇ AYDINLATMA

SİNYAL LAMBALARI

	ECE	Ref. No	V	W	Taban	Parça/Paket	Ambalaj
	(Stop P22)	174113000	12	15	BA15s	200	CP
	(Stop P25) BA15s	175113000	12	18	BA15s	200	CP
	P21W	176353000	12	21	BA15s	200	CP
		176354000	12	21	BA15s	10	B2
		176403000	12	21	BAU15s	200	CP
	PY21W Amber	176383000	12	21	BAU15s	200	CP
		176384000	12	21	BAU15s	10	B2

	ECE	Ref. No	V	W	Taban	Parça/Paket	Ambalaj
	P21/4W	178813000	12	21/4	BAZ15d	200	CP
		178814000	12	21/4	PX26d	10	B2
	P21/5W	179163000	12	21/5	BAY15d	200	CP
		179164000	12	21/5	BAY15d	10	B2
	(Stop P25) BA15d	179183000	12	21/5	BA15d	200	CP
	R5W BA15s	171713000	12	5	BA15s	200	CP
		171714000	12	5	BA15s	10	B2
	R5W BA15d	171723000	12	5	BA15d	200	CP
	R10W	173113000	12	10	BA15s	200	CP
		173114000	12	10	BA15s	10	B2
	RY10W	173173000	12	10	BAU15s	200	CP
		170513000	12	2	BA7s	200	CP
		170533000	12	2	BA9s	200	CP
	T4W	171313000	12	4	BA9s	200	CP



SİNYALLER VE İÇ AYDINLATMA

HALOJEN MINİYATÜR LAMBALAR

ECE	Ref. No	V	W	Taban	Parça/Paket	Ambalaj
(H5W)	178303000	12	5	BA9s	200	CP
H6W	681613000	12	6	BAX9s	200	CP
(H10W)	178333000	12	10	BA9s	200	CP
(H20W)	178353000	12	20	BA9s	200	CP
H21W	681913000	12	21	BAY9s	200	CP

SİNYALLER VE İÇ AYDINLATMA

KAMA TABANLI LAMBALAR

ECE	Ref. No	V	W	Taban	Parça/Paket	Ambalaj
(W1,2W) Frosted	170323000	12	1.2	W2x4,6d	200	CP
(W1,2W)	170373000	12	1.2	W2x4,6d	200	CP
(W2,2W)	170593000	12	2.2	W2,1x9,5d	200	CP
W2,3W	170733000	12	2.3	W2x4,6d	200	CP

ECE	Ref. No	V	W	Taban	Parça/Paket	Ambalaj
W3W	170973000	12	3	W2,1x9,5d	200	CP
W5W	171773000 171774000	12 12	5 5	W2,1x9,5d W2,1x9,5d	200 10	CP B2
WY5W	171693000	12	5	W2,1x9,5d	200	CP
W16W	176313000	12	16	W2,1x9,5d	200	CP
W21W	176323000	12	21	W3x16d	200	CP
WY21W	176293000	12	21	WX3x16d	200	CP
W21/5W	179193000	12	21/5	W3x16q	200	CP

SİNYALLER VE İÇ AYDINLATMA

FESTON LAMBALAR

ECE	Ref. No	V	W	Taban	Parça/Paket	Ambalaj
T8.2x30	170943000	12	3	SV7,5	200	CP
C5W	171253000 171254000	12 12	5 5	SV8,5 SV8,5	200 10	CP B2



ECE	Ref. No	V	W	Taban	Parça/Paket	Ambalaj
T10.5x43	171753000	12	5	SV8,5	200	CP

ECE	Ref. No	V	W	Taban	Parça/Paket	Ambalaj
T10.5x43	173143000	12	10	SV8,5	200	CP

ECE	Ref. No	V	W	Taban	Parça/Paket	Ambalaj
T10.5x30	173153000	12	10	SV8,5	200	CP

ECE	Ref. No	V	W	Taban	Parça/Paket	Ambalaj
T10.5x38	173163000	12	10	SV8,5	200	CP

ECE	Ref. No	V	W	Taban	Parça/Paket	Ambalaj
T15x43	175123000	12	18	SV8,5	200	CP

ECE	Ref. No	V	W	Taban	Parça/Paket	Ambalaj
C21W	176343000	12	21	SV8,5	200	CP

SİNYALLER VE İÇ AYDINLATMA

PLASTİK TABANLI LAMBALAR (BAX)

ECE	Ref. No	V	W	Taban	Parça/Paket	Ambalaj
	170063000	12	0.4	Bax 8,5d blue violet	200	CP

ECE	Ref. No	V	W	Taban	Parça/Paket	Ambalaj
	170193000	12	1	Bax 8,5d orange	200	CP

ECE	Ref. No	V	W	Taban	Parça/Paket	Ambalaj
	170273000	12	1.2	Bax 8,4d light blue	200	CP

ECE	Ref. No	V	W	Taban	Parça/Paket	Ambalaj
	170283000	12	1.2	Bax 8,4d black	200	CP

ECE	Ref. No	V	W	Taban	Parça/Paket	Ambalaj
	170293000	12	1.2	Bax 8,5d blue	200	CP

ECE	Ref. No	V	W	Taban	Parça/Paket	Ambalaj
	170353000	12	1.2	Bax 8,5d black	200	CP

ECE	Ref. No	V	W	Taban	Parça/Paket	Ambalaj
	170363000	12	1.2	Bax 8,3d black	200	CP

ECE	Ref. No	V	W	Taban	Parça/Paket	Ambalaj
	170463000	12	1.1	Bax 8,4d orange	200	CP

ECE	Ref. No	V	W	Taban	Parça/Paket	Ambalaj
	170473000	12	1.3	Bax 8,4d olive green	200	CP





ECE	Ref. No	V	W	Taban	Parça/Paket	Ambalaj
	170483000	12	1.5	Bax 8,4d beige	200	CP

ECE	Ref. No	V	W	Taban	Parça/Paket	Ambalaj
	170493000	12	1.5	Bax 8,5d beige	200	CP

ECE	Ref. No	V	W	Taban	Parça/Paket	Ambalaj
	170503000	12	1.5	Bax 8,5d yellow	200	CP



ECE	Ref. No	V	W	Taban	Parça/Paket	Ambalaj
	170523000	12	2	Bax 8,5d light green	200	CP



	ECE	Ref. No	V	W	Taban	Parça/Paket	Ambalaj
		170543000	12	2	Bax 8,4d light green	200	CP
		170573000	12	2	Bax 8,5d green	200	CP
		170583000	12	2	Bax 8,3d blue	200	CP
		170603000	12	1.8	Bax 8,4d beige	200	CP
		171633000	12	5	Bax 10d black	100	C1



SİNYALLER VE İÇ AYDINLATMA

RANGE POWER BLUE+

	ECE	Ref. No	V	W	Taban	Parça/Paket	Ambalaj
	W5W RPB+	171893000	12	5	W2,1x9,5d	200	CP
	H6W RPB+	681633000	12	6	BAX9s	200	CP

SİNYALLER VE İÇ AYDINLATMA

AMERIKAN TIPLERİ

	Amerikan Tipi	Ref. No	V	W	Taban	Parça/Paket	Ambalaj
	3156	179413000	12.8	32CP	W2,5x16d	200	CP
	3157	179453000	12.8/14	32/3CP	W2,5x16q	200	CP
	3157 NA	179483000	12.8/14	24/2.2CP	W2,5x16q	200	CP







YEDEK KİTLERİ



STANDARD

Birçok Avrupa ülkesinde araçta yedek kit bulundurulması zorunludur veya önerilir. Yedek kitlerimiz sürücülere yolda ya da seyahatte ihtiyaç duydukları güvenliği sunar.

Açıklama	Ref. No	İçindekiler	W	Taban	Parça adedi	
	980043010	H4	60/55	P43t	1	
		P21W	21	BA15s	1	
		R5W	5	BA15s	1	
		W5W	5	W2,1x9,5d	1	
		Düz sigortalı			2	
		Ambalajdaki adet				20
	984003010	H4	60/55	P43t	1	
		P21/5W	21/5	BAY15d	1	
		P21W	21	BA15s	1	
		R5W	5	BA15s	1	
		C5W	5	SV8,5	1	
		W5W	5	W2,1x9,5d	1	
		Düz sigortalı			4	
		Ambalajdaki adet				20
			984353010	H7	55	PX26d
17	55			P14,5s	1	
P21/5W	21/5			BAY15d	1	
P21W	21			BA15s	1	
PY21W	21			BAU15s	1	
C5W	5			SV8,5	1	
W5W	5			W2,1x9,5d	1	
Düz sigortalı					4	
Ambalajdaki adet						20

YEDEK KİTLERİ

RANGE POWER WHITE*

Açıklama	Ref. No	İçindekiler	W	Taban	Parça adedi
	980142100	H1	85	P14,5s	2
		W5W	5	W2,1x9,5d	2
		Ambalajdaki adet			10
	980152100	H4	100/90	P43t	2
		W5W	5	W2,1x9,5d	2
		Ambalajdaki adet			10
	980162100	H7	85	P14,5s	2
		W5W	5	W2,1x9,5d	2
		Ambalajdaki adet			10

*Önemli: ECE sertifikası logosunu taşımayan ürünler onaylı değildir ve Avrupa'da satılamaz.

SATIŞ ARAÇLARI

	Tezgâh standı		Zemin standı
	GOC: 98027700 Aşağıdakilerle birlikte verilir: ▪ 20x H7 Standard C1 ▪ 10x H4 Standard C1		GOC: 99026700 Dayanıklı karton zemin standı, boş teslim edilir. ▪ 12 kanca ▪ Değiştirilebilir başlık
	Duvar otomatı	GOC (boş): 0980173000	GOC (dolü): 0980223000
	Dolu versiyon aşağıdaki lambalarla birlikte teslim edilir. Dayanıklı metal muhafaza Kompakt boyut: 37 x 17.6 x 59.5 cm Kilitlenebilir Aşağıdakilerle birlikte verilir ▪ 10x H1 ▪ 10x H3 ▪ 30x H4 ▪ 50x H7 ▪ 30x P21/5W	▪ 30x P21W ▪ 30x R5W BA15 ▪ 30x R10W ▪ 30x T4W ▪ 30x C5W	▪ 20x Fest T10,5x43 ▪ 20x W1,2W ▪ 20x W3W ▪ 30x W5W



NASIL BİR 24V LAMBAYA İHTİYACINIZ VAR?



YAN LAMBALAR



KISA FAR
UZUN FAR



ÖN GÖSTERGELER



ARKA GÖSTERGELER



ARKA PARK
LAMBALARI



GERİ
MANEVRA IŞIĞI



INTERIOR LIGHTS



PLAKA IŞIKLARI

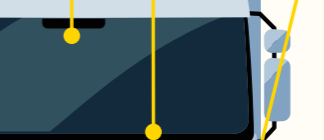

ARKA SIS FARLARI



GÖSTERGE KADRANI
IŞIKLARI



ÖN SIS FARLARI



ÖN PARK
LAMBALARI



YAN GÖSTERGELER



STOP LAMBALARI



Titreşim direncini yüksek kaliteyle birleştiren 24 V aydınlatma serilerimiz, günümüzün kamyonları ve diğer ağır araçları için sağlam ve güvenilirlerdir.

NARVA kamyon farları, titreşim direnci ve üstün kalite sunar.

Daha fazla güç ve dayanıklılık gerektiğinde 24 V serimize göz atın.



FARLAR

STANDARD

	ECE	Ref. No	V	W	Taban	Parça/Paket	Ambalaj
	H1	487023000	24	70	P14,5s	100	C1
		487024000	24	70	P14,5s	10	B1
	H2	487203000	24	70	X511	100	C1
	H3	487003000	24	70	PK22s	100	C1
	H4	488923000	24	75/70	P43t	100	C1
		488924000	24	75/70	P43t-38	10	B1
	H7	487283000	24	70	PX26d	100	C1
		487284000	24	70	PX26d	10	B1
	R2 Halojen	481323000	24	55/50	P45t-41	100	C1
	R2	493213000	24	55/50	P45t	100	C1





FARLAR

HEAVY DUTY

	ECE	Ref. No	V	W	Taban	Parça/Paket	Ambalaj
	H1 HD	487083000	24	70	P14,5s	100	C1
	H3 HD	487093000	24	70	PK22s	100	C1
	H4 HD	488983000	24	75/70	P43t-38	100	C1
	H7 HD	487293000	24	70	PX26d	100	C1

FARLAR

RALLYE*

	Tipi	Ref. No	V	W	Taban	Parça/Paket	Ambalaj
	H1 Rallye	483503000	12	100	P14,5s	100	C1
		483803000	12	130	P14,5s	100	C1
	H3 Rallye	483513000	12	100	PK22s	100	C1
		483813000	12	130	PK22s	100	C1
	H4 Rallye	489013000	12	100/90	P43t-38	100	C1
		489014000	12	100/90	P43t-38	10	B1
	P43t	489113000	12	100/55	PX26d	100	C1
		489513000	12	130/100	P43t	100	C1
	H4 Rallye P45t	488943000	24	75/70	P45t-41	100	C1
		489943000	24	100/90	P45t-41	100	C1

*Önemli: ECE sertifikası logosunu taşımayan ürünler onaylı değildir ve Avrupa'da satılamaz.



24V | KAMYON

GELENEKSEL
AMPULLER



ECE	Ref. No	V	W	Taban	Parça/Paket	Ambalaj
T4W	171413000	24	4	BA9s	200	CP
P21W	176433000	24	21	BA15s	200	CP
P21/4W	178823000	24	21/4	BAZ15d	200	CP
P21/5W	179253000	24	21/5	BAY15d	200	CP
Stop P22	174213000	24	15	BA15s	200	CP
R5W	171813000	24	5	BA15s	200	CP
BA15s	171814000	24	5	BA15s	10	B2
R5W	171823000	24	5	BA15d	200	CP
R10W	173223000	24	10	BA15d	200	CP
	170613000	24	3	BA7s	200	CP
	170633000	24	2	BA9s	200	CP



ECE	Ref. No	V	W	Taban	Parça/Paket	Ambalaj
T4W	171413000	24	4	BA9s	200	CP



ECE	Ref. No	V	W	Taban	Parça/Paket	Ambalaj
H21W	681963000	24	21	BAY9s	200	CP



SİNYALLER VE İÇ AYDINLATMA

KAMA TABANLI
LAMBALAR

ECE	Ref. No	V	W	Taban	Parça/Paket	Ambalaj
(W1,2W)	170403000	24	1.2	W2x4,6d	200	CP
ECE	Ref. No	V	W	Taban	Parça/Paket	Ambalaj
W3W	171093000	24	3	W2,1x9,5d	200	CP
ECE	Ref. No	V	W	Taban	Parça/Paket	Ambalaj
W5W	171973000	24	5	W2,1x9,5d	200	CP

SİNYALLER VE İÇ AYDINLATMA

FESTON LAMBALAR





ECE	Ref. No	V	W	Taban	Parça/Paket	Ambalaj
T8.2x30	171043000	24	3	SV7,5	200	CP
ECE	Ref. No	V	W	Taban	Parça/Paket	Ambalaj
C5W	171363000	24	5	SV8,5	200	CP
ECE	Ref. No	V	W	Taban	Parça/Paket	Ambalaj
T10.5x43	171853000	24	5	SV8,5	200	CP
ECE	Ref. No	V	W	Taban	Parça/Paket	Ambalaj
T10.5x43	173273000	24	10	SV8,5	200	CP
ECE	Ref. No	V	W	Taban	Parça/Paket	Ambalaj
T15x43	175223000	24	18	SV8,5	200	CP

SİNYALLER VE İÇ AYDINLATMA

PLASTİK TABANLI
LAMBALAR (BAX)

ECE	Ref. No	V	W	Taban	Parça/Paket	Ambalaj
	170223000	24	1.2	EBS-R4 yellow	200	CP
ECE	Ref. No	V	W	Taban	Parça/Paket	Ambalaj
	170383000	24	1.2	Bax 8,3d grey	200	CP
ECE	Ref. No	V	W	Taban	Parça/Paket	Ambalaj
	170393000	24	1.2	Bax 8,5d grey	200	CP
ECE	Ref. No	V	W	Taban	Parça/Paket	Ambalaj
	170673000	24	1.8	Bax 8,4d blue	200	CP
ECE	Ref. No	V	W	Taban	Parça/Paket	Ambalaj
	170763000	24	1.2	Bax 8,5d brown	200	CP
ECE	Ref. No	V	W	Taban	Parça/Paket	Ambalaj
	170813000	24	1.4	REF29 white	200	CP
ECE	Ref. No	V	W	Taban	Parça/Paket	Ambalaj
	170823000	24	1.4	Bax 8,4d light green	200	CP
ECE	Ref. No	V	W	Taban	Parça/Paket	Ambalaj
	171023000	24	1.2	EBS-R6 brown	200	CP
ECE	Ref. No	V	W	Taban	Parça/Paket	Ambalaj
	171033000	24	1.2	EBS-R white 1,25 mm FR	200	CP
ECE	Ref. No	V	W	Taban	Parça/Paket	Ambalaj
	170723000	24	1.2	EBS-R white frosted	200	CP



	ECE	Ref. No	V	W	Taban	Parça/Paket	Ambalaj
	P21W HD	176443000	24	21	BA15s	200	CP
	PY21W HD	176493000	24	21	BAU15s	200	CP
	T4W HD	171433000	24	4	BA9s	200	CP
	R5W HD	171863000	24	5	BA15s	200	CP
	R10W HD	173283000	24	10	BA15s	200	CP

YEDEK KİTLERİ

Birçok Avrupa ülkesinde araçta yedek kit bulundurulması zorunludur veya önerilir. Yedek kitlelerimiz sürücülere yolda ya da seyahatte ihtiyaç duydukları güvenliği sunar.



Açıklama	Ref. No	İçindekiler	W	Taban	Parça adedi
Yedek kiti H4	986143010	H4	75/70	P43t	2
		P21W	21	BA15s	6
		R10W	10	BA15s	2
		C10W	10	SV8,5	2
		W5W	5	W2,1x9,5d	2
		Düz sigortalı			8
Ambalajdaki adet					20



Açıklama	Ref. No	İçindekiler	W	Taban	Parça adedi
Yedek kiti H7	986303010	H7	70	PX26d	2
		P21W	21	BA15s	4
		PY21W	21	BA15s	2
		R10W	10	BA15s	2
		C10W	10	SV8,5	2
		W5W	5	W2,1x9,5d	2
Düz sigortalı					3
Ambalajdaki adet					20

SATIŞ ARAÇLARI



Duvar otomatı

GOC (boş): 0980173000

GOC (dolü): 990287000

Dolu versiyon aşağıdaki lambalarla birlikte teslim edilir.

Dayanıklı metal muhafaza

Kompakt boyut: 37 x 17.6 x 59.5 cm

Kilitlenebilir

Aşağıdakilerle birlikte verilir

- 15x H1
- 15x H3
- 10x H4
- 20x H7
- 10x P21W
- 10x PY21W HD
- 10x R5W
- 10x R10W
- 10x T4W
- 10x W3W
- 10x W5W
- 10x W1,2W
- 10x C5W

İKİ TEKERLEKLİ ARAÇ 12 V LAMBALAR



NARVA günümüzün zorlu sürüş koşullarına uygun motosiklet aydınlatması sunar. Motosiklet lambalarımız motor sürücülerini için gereken görünürlüğü ve güvenliği sağlar.

NASIL BİR İKİ TEKERLEKLİ ARAÇ LAMBASINA İHTİYACINIZ VAR?



**KISA FAR
UZUN FAR**



ÖN GÖSTERGELER



**ARKA PARK
LAMBALARI**



PLAKA IŞIKLARI

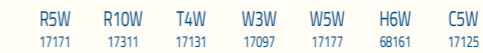

**ÖN PARK
LAMBALARI**



STOP LAMBALARI



ARKA GÖSTERGELER



12V | İKİ TEKERLEKLİ ARAÇ

GELENEKSEL
AMPULLER

	ECE H51	Ref. No 482203000	V 12	W 35/35	Taban PX43t	Parça/Paket 100	Ambalaj C1
	ECE H3	Ref. No 483013000	V 6	W 55	Taban PK22s	Parça/Paket 100	Ambalaj C1
	ECE H4 Rallye	Ref. No 482223000	V 12	W 35/35	Taban P43t-38	Parça/Paket 100	Ambalaj C1
	ECE S3	Ref. No 490143000 490043000	V 12 6	W 15 15	Taban P26s P26s	Parça/Paket 200 200	Ambalaj CP CP
	ECE (M5) P15d-25-1	Ref. No 420073000 420053000 420013000	V 12 12 12	W 35/35 25/25 18/18	Taban P15d-25-1 P15d-25-1 P15d-25-1	Parça/Paket 100 100 100	Ambalaj C1 C1 C1
	ECE (M5) P15d-25-3	Ref. No 420173000 420153000	V 12 12	W 35/35 25/25	Taban P15d-25-3 P15d-25-3	Parça/Paket 100 100	Ambalaj C1 C1
	ECE (M5) BA20d	Ref. No 420273000 420253000	V 12 12	W 35/35 25/25	Taban BA20d BA20d	Parça/Paket 100 100	Ambalaj C1 C1

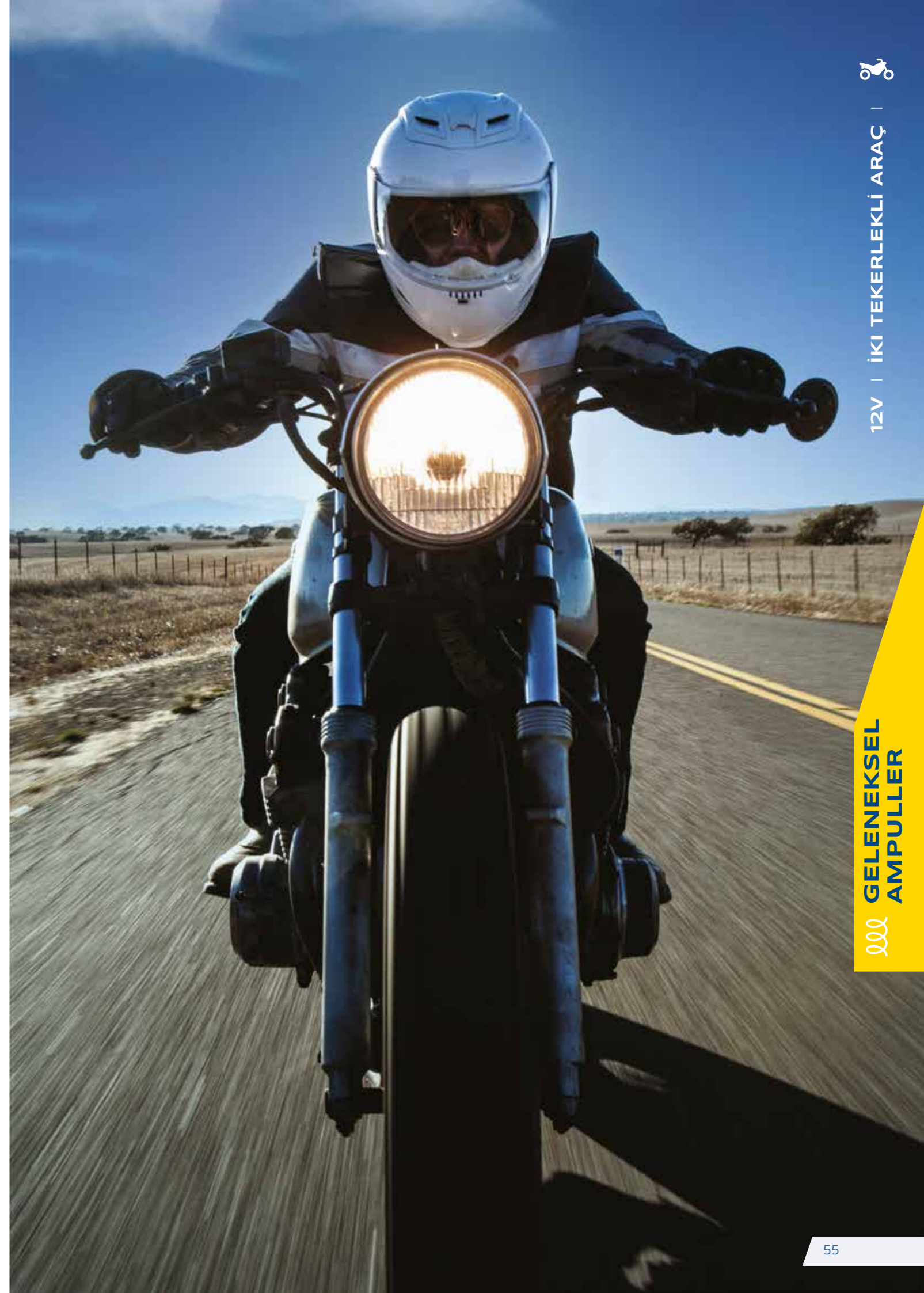

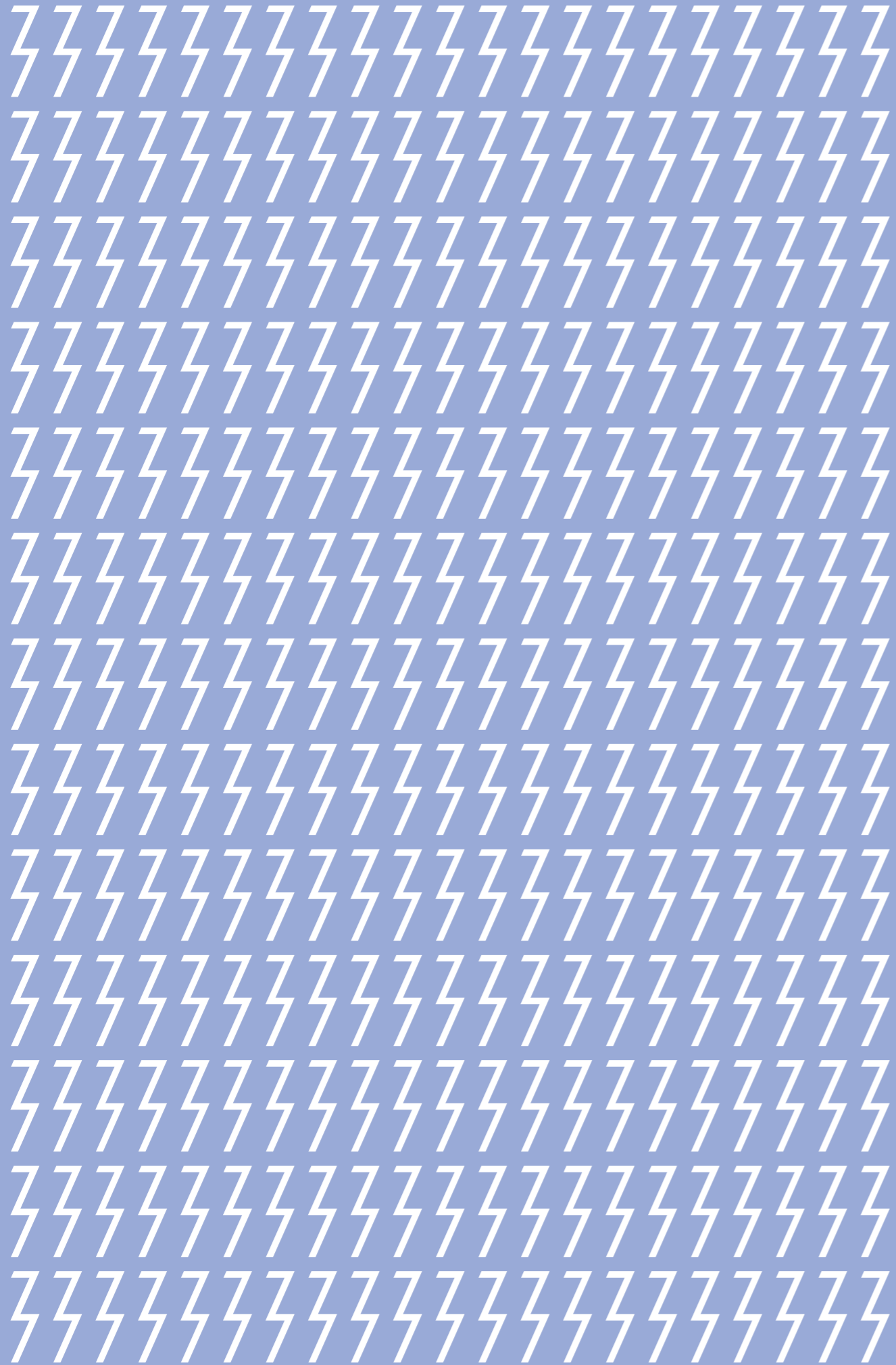

XENON ÇÖZÜMLERİ

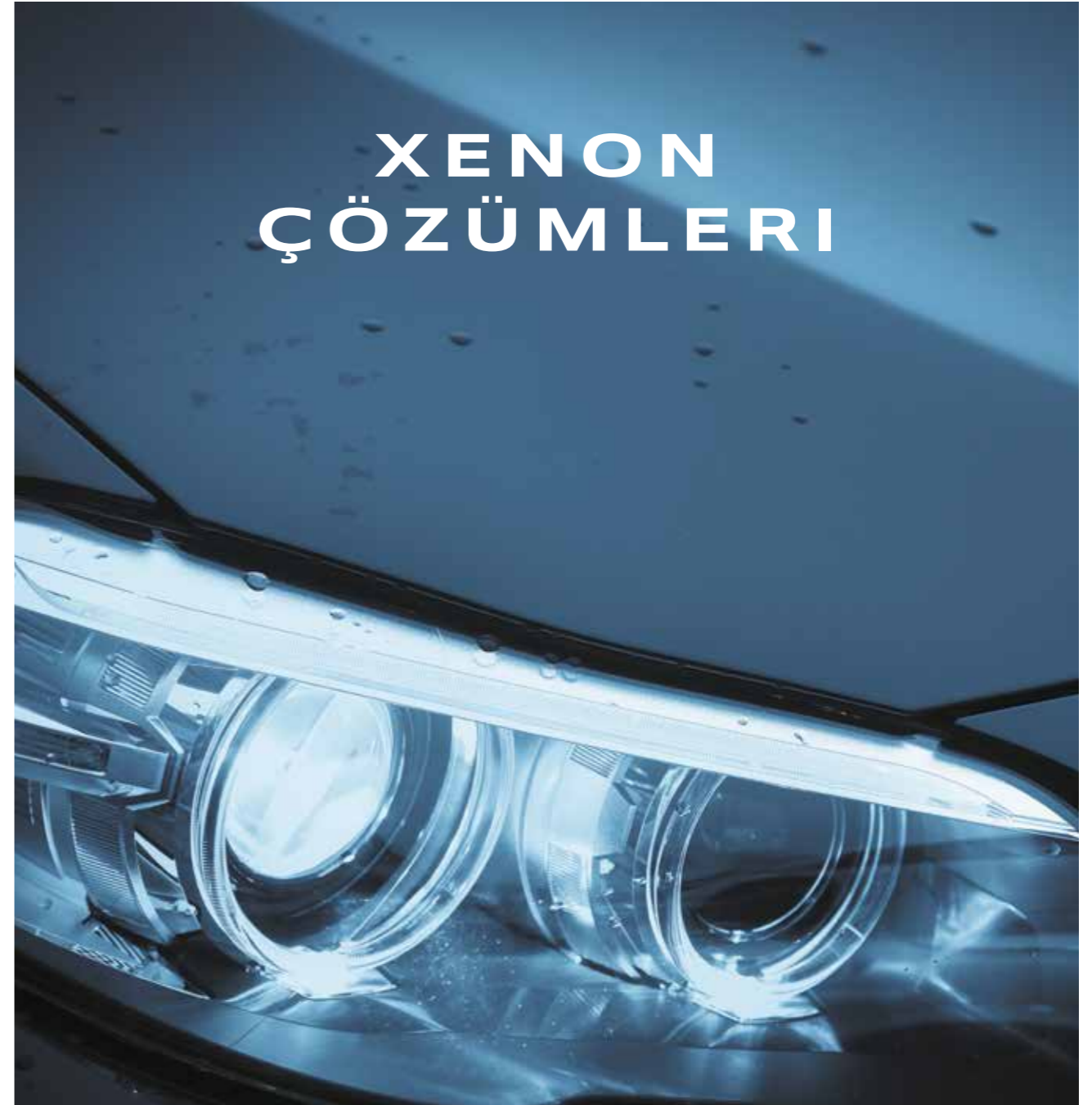

OTOMOBİL VE KAMYON



- D1S
- D1R
- D2S
- D2R
- D3S
- D3R
- D4S

XENON LAMBALAR



HANGİ XENON LAMBAYA İHTİYACINIZ VAR?



KISA FAR
UZUN FAR



Parlak, beyaz bir ışık ve hassas bir ışın üreten **NARVA** xenon serisi daha fazla güvenlik için daha fazla görünürlük sunar. **NARVA** xenon teknolojisi, uzun kullanım ömrü ve yolda parlak ışık sunar.

UV ışınlarını bloke eden kuvars cama sahip bu aydınlatma çözümü, sürücülerin daha uzağı görmesine olanak tanıyarak mükemmel bir görünürlükle birlikte maksimum güvenlik sunar.

XENON AYDINLATMA SİSTEMLERİNİ ANLAMA

Ana avantajlar

- / Yola mükemmel ve güçlü ışık yansıtma
- / Gün ışığına yakın ışık rengi ve yoğunluğu
- / Daha uzun kullanım ömrü
- / Düşük güç tüketimin



Xenon HID
(Yüksek Yoğunluklu Deşarj)
lambası

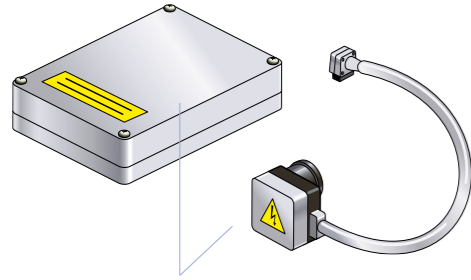

Electronic balast
ve yüksek voltajlı starter

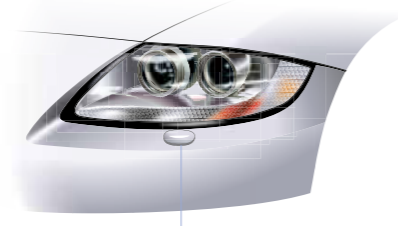

Otomatik düzey kontrolü özellikli
ve güçlü yıkama sistemli karmaşık
optik sistem



OTOMOBİL VE KAMYON

FARLAR

STANDARD

	ECE	Ref. No	V	W	Taban	Parça/Paket	Ambalaj
	D1S	840103000	85	35	PK32d-2	2	C1
	D1R	840113000	85	35	PK32d-3	2	C1
	D2S	840023000	85	35	P32d-2	2	C1
	D2R	840063000	85	35	P32d-3	2	C1
	D3S	840323000	42	35	PK32d-5	2	C1
	D4S	840423000	42	35	P32d-5	2	C1

TABANLAR (IEC 60061-1)

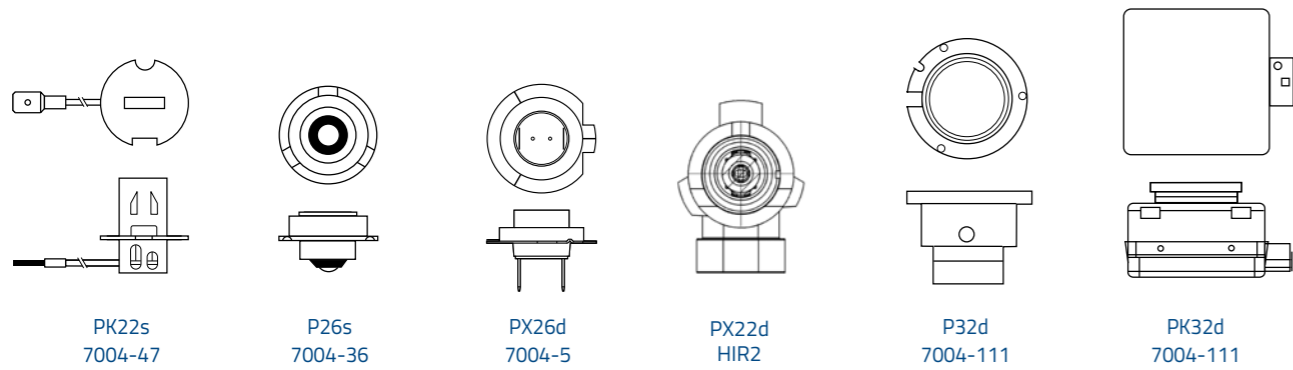
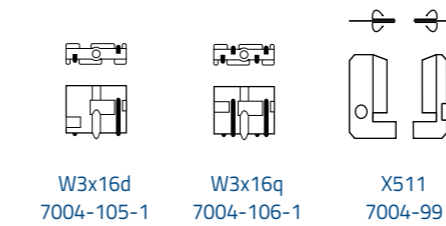
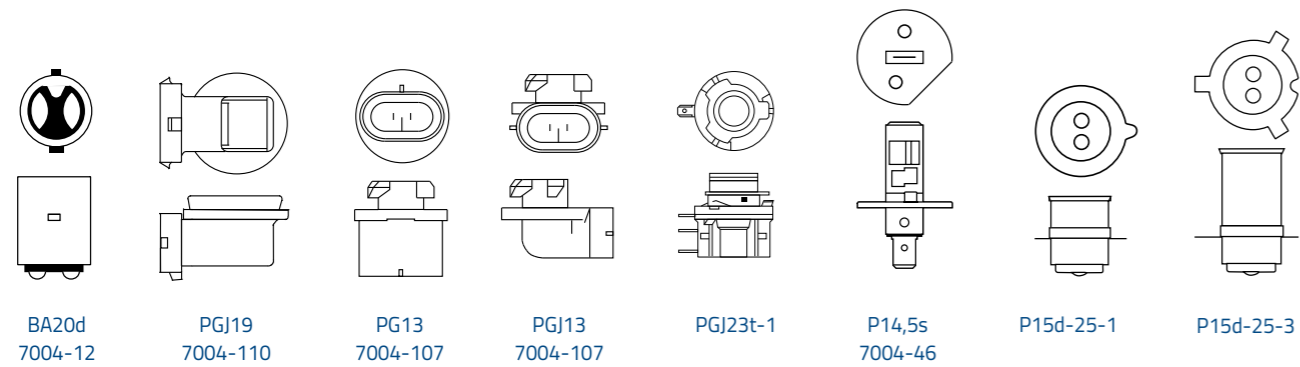
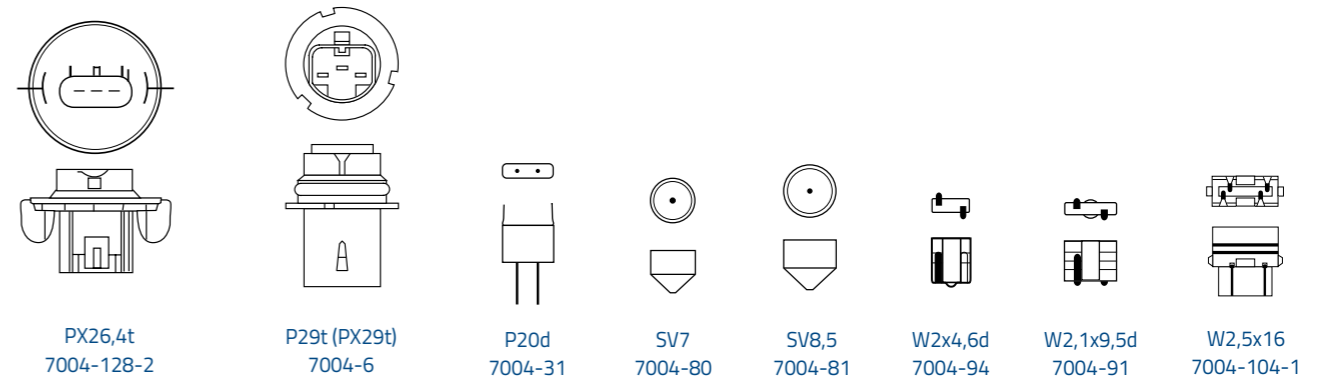
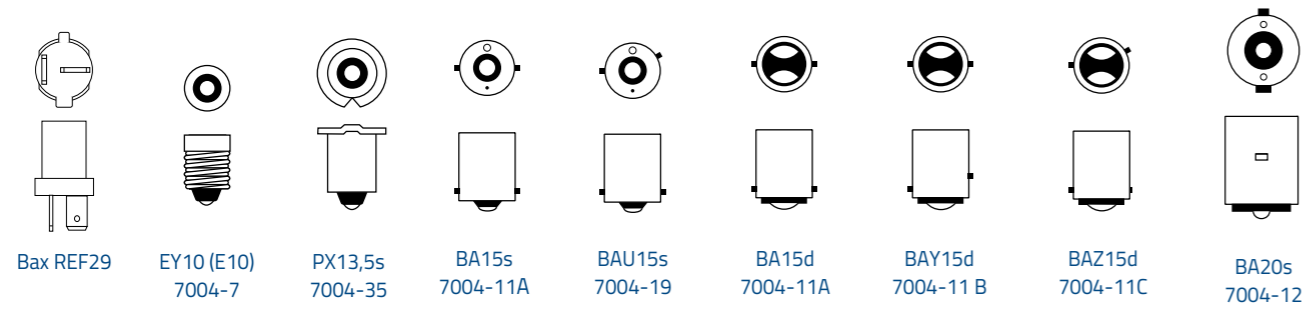
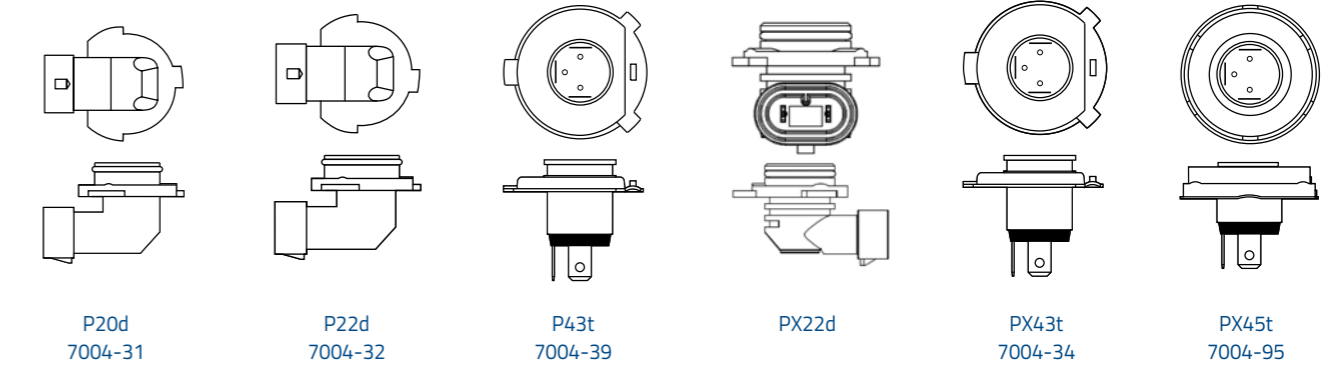
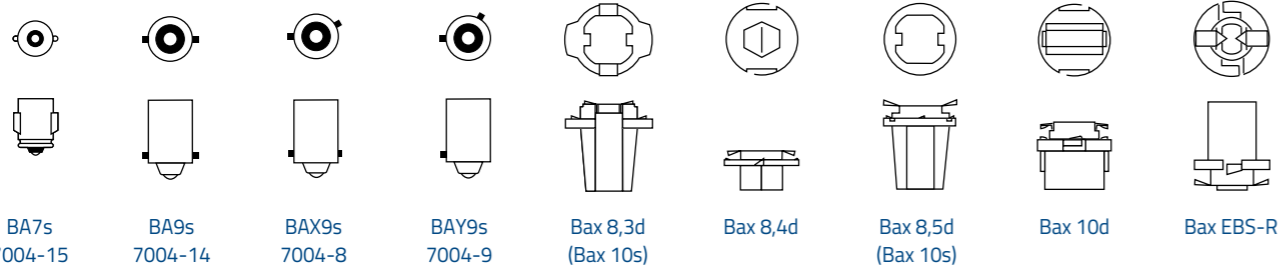



TiTOMOBİLi ambalaj



Blister



Yedek kitleri



C1/CP
TiTOMOBİLi ambalaj
3000



S2/SM
Special ikili paket
2100



B1/B2
Tek blister / Çift blister
4000



x2
Led için özel ikili ambalaj
3000

AMBALAJ



NARVA sipariş kodunu anlama

BETTER VISION
RANGE
POWER 50+
12V 60/55W - P43t-38
488612100

Ambalaj türü kodu

Sipariş kodu

NARVA Special ambalajı

Paketlerimiz, hem Özel çift paketler hem de Yedek setler için kullanılır. Ürün bilgileri ambalajın arka tarafında basit ve açık biçimde görüntülenerek, tüketicilerin bilinçli tercih yapmalarına yardımcı olmak hedeflenmiştir.

Çekici ambalaj tasarımı paketin içindeki ürünün rahatça görülebilmesini sağlar ve sağlam ambalaj malzemesi de ürünü nakliyenin yanı sıra mağazada da korur.

- / Ekonomik
- / Ağırlığı azaltır
- / Açık bilgi
- / Sağlam yapı

Ürün grubu adı kısaltmaları

HD	Heavy Duty Her türlü titreşime dayanıklı	RPB+	Range Power Blue+ %50'ye kadar daha fazla görüş, şık beyaz
LL	Long Life İki kat kullanım ömrü	RPW	Range Power White* 4500 K Xenon beyazı
RA	Rallye* Mükemmel parlaklık	RPA	Range Performance Advanced LED** 6000k beyaz ışık
RP50+	Range Power 50+ %50'ye kadar daha fazla görüş		
RP150	Range Power 150 %150'ye daha fazla parlaklık		

*Önemli: ECE sertifikası logosunu taşımayan ürünler onaylı değildir ve Avrupa'da satılamaz.



**LED retrofit ışıkların kullanımının geçerli yasal gereksinimlere uygun olmasının sorumluluğu size aittir.

NARVA

D A S L I C H T

Lumileds Germany GmbH

Philipsstraße 8
52068 Aachen
Germany

Tel. +49 (0)3741 746 8181
E-mail: info@narva-light.com
www.narva-light.com

© 2024 Lumileds Holding B.V.
TR-TR • Temmuz 2024

Member of **NARVA e.V. Germany** ///